



Emballages alimentaires



fibre de canne

bois & bambou

carton

nappage

plastique

sacherie

aluminium

CATALOGUE

2023

Catalogue 2023

Sommaire

| | |
|---|-----|
| Gamme fibre de canne | 38 |
| Gamme bois et bambou | 48 |
| Gamme rouleau aluminium et film étirable alimentaire | 54 |
| Gamme aluminium | 62 |
| Gamme plastique | 86 |
| Gamme sacherie | 174 |
| Gamme nappage | 178 |
| Gamme accessoire | 186 |
| Index | 190 |

Guide des matériaux

| Dénomination | Matière | Tenue en température |
|--------------|---|---|
| PS | Polystyrène OPS – polystyrène bi-orienté | - 5 °C / + 80 °C - 5 °C / + 80 °C |
| APET | Polyéthylène terephthalate amorphe (intègre le RPET) | - 40 °C / + 70 °C |
| PP | Polypropylène atténué, polypropylène | - 10 °C / + 80 °C - 20 °C / + 130 °C |
| ALU | Aluminium | - 20 °C / + 380 °C |

Légendes



Emballage alimentaire, vaisselle réutilisable ou compostable, nappage...

Happy birthday Aluplast !

Créée en 2003, Aluplast fête aujourd'hui ses 20 ans ! C'est fort d'une longue expérience dans le domaine de l'emballage alimentaire que depuis 20 ans nous concevons et distribuons une gamme complète de conditionnements et de vaisselle, dédiée à l'industrie agroalimentaire, aux professionnels des métiers de bouche et aux organisateurs d'événements festifs.

Toujours à l'avant-garde des nouveautés nous vous accompagnons dans vos choix d'emballages selon l'utilisation finale de ceux-ci et les attentes de vos clients.

Notre plateforme logistique de 25 000 m², implantée aux portes de Paris, regroupe 2 800 références disponibles en stock.

Chaque jour, nos produits sont livrés dans la France entière, les DOM-TOM et l'Europe.

Nos objectifs : vous proposer des contenants aux designs originaux, respectant les normes alimentaires en vigueur, dans les meilleurs délais. Aluplast, professionnel de l'emballage alimentaire dédié aux professionnels.

**Merci pour votre confiance accordée et votre fidélité.
En route, ensemble, pour les 20 prochaines années !**

L'Équipe ALUPLAST



Nos engagements chez Aluplast.

Depuis plusieurs années, nous plaçons le développement durable au cœur de nos activités.

La politique RSE est intégrée dans la stratégie globale du groupe AMBIPACK. Un responsable RSE unique est mandaté afin d'en assurer le respect.

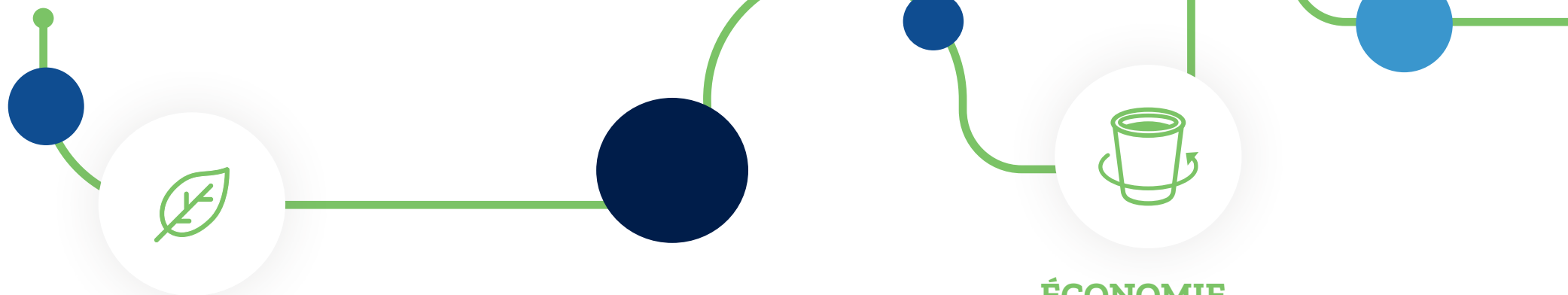

ENVIRONNEMENT

Conscient de sa **responsabilité sociétale** en tant qu'entreprise, Aluplast s'est engagée résolument sur la voie d'un développement durable, manager de l'environnement **depuis 2014** avec le programme **Valid'Action Environnement** conçu par la CCI de Versailles Val-d'Oise/Yvelines et les acteurs institutionnels de l'environnement, ADEME, AESN, DRIRE, CRITT Chimie Environnement.

APPLICATIONS :

- Tri sélectif et valorisation des déchets.
- Réduction de l'impact carbone.
- Réduction des consommations (énergie, matières...).
- Fédération du personnel sur le développement d'idées durables.

ÉCONOMIE

Nous sommes engagés dans des démarches pour des achats responsables :

- Création et développement d'emballages qui génèrent moins de déchets et peuvent être entièrement recyclés ou réutilisés.
- Utilisation de matières recyclables et renouvelables.
- Réduction de l'impact carbone par des achats et une fabrication européenne et française.

Nous sommes engagés à promouvoir des relations saines et équilibrées avec nos partenaires et clients.



SOCIAL

À travers l'instauration d'un **dialogue social**, Aluplast favorise l'implication des instances représentatives du personnel à tous les projets de l'entreprise et le respect du code du travail.

Pour cela Aluplast veille à :

- Améliorer la qualité de vie au travail.
- Garantir la sécurité au travail des collaborateurs.
- Lutter contre toutes formes de discriminations.
- Promouvoir la diversité, l'inclusion et l'égalité homme/femme.
- Favoriser la formation des salariés.



RESPONSABILITÉ SOCIÉTALE

Aluplast est engagée dans sa Responsabilité Sociétale en s'inscrivant dans une **démarche et une dynamique collaboratives avec ses fournisseurs et sous-traitants**, en étant spécialement attentive **aux droits humains, aux libertés fondamentales, à la sécurité et à l'environnement**.

Aluplast soutient l'activité économique locale en participant à la vie des entreprises locales au sein de l'APHIE (Association des Industries et Entreprises du Pays Houdanais).





Gamme carton





p. 06 – p. 37

| | |
|---|----|
| Gobelet | 10 |
| Gobelet blanc, gobelet brun | 11 |
| Gobelet froid Emocath, couvercle en carton | 12 |
| Personnalisation emballages | 13 |
| Porte-gobelets, gobelet conique, distributeur | 14 |
| Pot à soupe kraft brun | 16 |
| Pot à soupe blanc | 17 |
| Coque hamburger | 18 |
| Boîte salade, boîte take away | 19 |
| Barquette rectangulaire, cornet à frites | 20 |
| Barquette four, Food box | 21 |
| Pot salade kraft brun | 22 |
| Pot salade blanc | 23 |

| | |
|---|----|
| Pot à pâtes blanc, pot wrap blanc | 24 |
| Pot à pâtes kraft, pot wrap kraft | 25 |
| Pot bucket, pot whizz | 26 |
| Pot plissé, coupe à glace, dôme pour coupe | 27 |
| Boîte à pizza | 28 |
| Trépied pizza | 29 |
| Plateau traiteur | 30 |
| Plateau | 32 |
| Boîte lunch, carré rainé, part pizza, part quiche | 33 |
| Boîte pâtissière blanche | 34 |
| Boîte pâtissière décor | 35 |
| Sac kraft | 36 |
| Personnalisation sac publicitaire | 37 |

Assiette carton



| n° |  |  |  |  |  |
|----|---|---|---|---|---|
| 1 | ASCA 150 | Assiette carton | Ø 150 mm | Blanc | 10 × 100 |
| 2 | ASCA 180 BE | Assiette carton enduit | Ø 180 mm | Blanc | 10 × 100 |
| 3 | ASCA 230 | Assiette carton | Ø 230 mm | Blanc | 5 × 100 |
| 4 | ASCA 230 BE | Assiette carton enduit | Ø 230 mm | Blanc | 5 × 100 |
| 5 | ASCA 290 | Assiette carton | Ø 290 mm | Blanc | 5 × 50 |
| 6 | ACB 180 | Assiette carton brun | Ø 180 mm | Brun | 16 × 50 |
| 7 | ACB 230 | Assiette carton brun | Ø 230 mm | Brun | 16 × 50 |



ASCA 150



ASCA 180 BE



ASCA 230



ASCA 230 BE



ASCA 290



ACB 180



ACB 230





| n° | | | | | | | | | | |
|----|--------------------|-------------------------|---------|--------|---------|---------|----------|-------------|----------|--|
| 1 | GOB 10 COFFEE CHIC | Gobelet 10/12 cl carton | Ø 62 mm | 60 mm | Ø 56 mm | Ø 45 mm | 10/12 cl | Coffee chic | 20 × 100 | |
| 2 | GOB 17 COFFEE CHIC | Gobelet 17,5 cl carton | Ø 70 mm | 80 mm | Ø 64 mm | Ø 46 mm | 17,5 cl | Coffee chic | 20 × 100 | |
| 3 | GOB 24 COFFEE CHIC | Gobelet 24 cl carton | Ø 80 mm | 90 mm | Ø 75 mm | Ø 56 mm | 24 cl | Coffee chic | 20 × 50 | |
| 4 | GOB 30 COFFEE CHIC | Gobelet 30/35 cl carton | Ø 80 mm | 117 mm | Ø 75 mm | Ø 50 mm | 30/35 cl | Coffee chic | 20 × 50 | |

1



GOB 10 COFFEE CHIC

2



GOB 17 COFFEE CHIC

3



GOB 24 COFFEE CHIC

4



GOB 30 COFFEE CHIC

| n° | | | | | | | | | |
|----|--------------------|---|---------|--------|---------|---------|----------|-------|----------|
| 1 | GOB 10 WHITE CUP | Gobelet 10/12 cl carton | Ø 62 mm | 60 mm | Ø 56 mm | Ø 45 mm | 10/12 cl | Blanc | 20 × 100 |
| 2 | GOB 17 WHITE CUP | Gobelet 17,5 cl carton | Ø 70 mm | 80 mm | Ø 64 mm | Ø 45 mm | 17,5 cl | Blanc | 20 × 100 |
| 3 | GOB 17 WHITE INDIV | Gobelet carton emballé individuellement | Ø 70 mm | 80 mm | Ø 64 mm | Ø 45 mm | 17,5 cl | Blanc | 1000 |
| 4 | GOB 21 WHITE CUP | Gobelet 21 cl carton | Ø 70 mm | 90 mm | Ø 64 mm | Ø 46 mm | 21 cl | Blanc | 25 × 100 |
| 5 | GOB 24 WHITE CUP | Gobelet 24 cl carton | Ø 80 mm | 90 mm | Ø 75 mm | Ø 56 mm | 24 cl | Blanc | 20 × 50 |
| 6 | GOB 30 WHITE CUP | Gobelet 30/35 cl carton | Ø 80 mm | 117 mm | Ø 75 mm | Ø 50 mm | 30/35 cl | Blanc | 20 × 50 |
| 7 | GOB 35 WHITE CUP | Gobelet 35/42 cl carton | Ø 90 mm | 110 mm | Ø 84 mm | Ø 60 mm | 35/42 cl | Blanc | 20 × 50 |
| 8 | GOB 45 WHITE CUP | Gobelet 45/48 cl carton | Ø 90 mm | 135 mm | Ø 84 mm | Ø 60 mm | 45/48 cl | Blanc | 20 × 50 |
| 9 | GOB 60 WHITE CUP | Gobelet 50/65 cl carton | Ø 90 mm | 168 mm | Ø 84 mm | Ø 60 mm | 50/65 cl | Blanc | 20 × 50 |



NEW!



NEW!

| n° | | | | | | | | | |
|----|-------------|-------------------------|---------|--------|---------|---------|----------|------|----------|
| 1 | GOB 10 BRUN | Gobelet 10/12 cl carton | Ø 62 mm | 60 mm | Ø 56 mm | Ø 45 mm | 10/12 cl | Brun | 20 × 100 |
| 2 | GOB 17 BRUN | Gobelet 17,5 cl carton | Ø 70 mm | 80 mm | Ø 64 mm | Ø 45 mm | 17,5 cl | Brun | 20 × 100 |
| 3 | GOB 24 BRUN | Gobelet 24 cl carton | Ø 80 mm | 90 mm | Ø 75 mm | Ø 56 mm | 24 cl | Brun | 20 × 50 |
| 4 | GOB 30 BRUN | Gobelet 30/35 cl carton | Ø 80 mm | 117 mm | Ø 75 mm | Ø 50 mm | 30/35 cl | Brun | 20 × 50 |
| 5 | GOB 35 BRUN | Gobelet 35/42 cl carton | Ø 90 mm | 110 mm | Ø 84 mm | Ø 60 mm | 35/42 cl | Brun | 20 × 50 |
| 6 | GOB 45 BRUN | Gobelet 45/48 cl carton | Ø 90 mm | 135 mm | Ø 84 mm | Ø 60 mm | 45/48 cl | Brun | 20 × 50 |



NEW!



Gobelet blanc

Gobelet hôtel

Gobelet brun

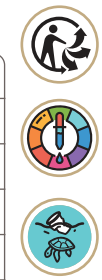
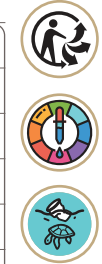

Gobelet froid Emocath



| n° | | | | | | | |
|----|----------------|---|---------|--------|----------|-------------|---------|
| 1 | GOB 25 EMOCATH | Gobelet 25/30 cl « Emocath » carton froid | Ø 80 mm | 118 mm | 25/30 cl | Multicolore | 20 × 50 |
| 2 | GOB 40 EMOCATH | Gobelet 40/50 cl « Emocath » carton froid | Ø 90 mm | 135 mm | 40/50 cl | Multicolore | 20 × 50 |
| 3 | GOB 50 EMOCATH | Gobelet 50/65 cl « Emocath » carton froid | Ø 90 mm | 168 mm | 50/65 cl | Multicolore | 20 × 50 |

Nouveau décor !



1 GOB 25 EMOCATH



2 GOB 40 EMOCATH



3 GOB 50 EMOCATH

Couvercle en carton



| n° | | | | | | | |
|----|-------------------|--|---------|-------|-------|---------|--|
| 7 | COUV GOB 10 BLANC | Couvercle blanc gobelet carton 10 | Ø 65 mm | 11 mm | Blanc | 20 × 50 | |
| 8 | COUV GOB 17 BLANC | Couvercle blanc gobelet carton 17 & 21 | Ø 70 mm | 11 mm | Blanc | 20 × 50 | |
| 9 | COUV GOB 25 BLANC | Couvercle blanc gobelet carton 24 & 30 | Ø 80 mm | 11 mm | Blanc | 20 × 50 | |
| 10 | COUV GOB 45 BLANC | Couvercle blanc gobelet carton 35, 45 & 60 | Ø 90 mm | 11 mm | Blanc | 20 × 50 | |

Compatibles gobelets
boisson chaude et froide

7



COUV GOB 10 BLANC

8



COUV GOB 17 BLANC

9



COUV GOB 25 BLANC

10



COUV GOB 45 BLANC

Personnalisable !

Aluplast vous propose
la personnalisation de vos emballages,
tout comme les gobelets carton,
boîtes burger, pots à pâtes...



Une gamme d'emballages personnalisés à votre image, un avantage pour développer votre notoriété. À partir de votre logo nous sommes en mesure de vous proposer un marquage composé de une à cinq couleurs Pantone® (y compris en quadrichromie).

La quantité minimale pour la personnalisation de gobelets est de 10 000 pièces par référence. Pour plus d'informations, consultez-nous.

Porte-gobelets



n°



| | | | | | | | |
|---|------------------|--------------------------|--------------|-------|------------|------|-----|
| 1 | PORTE 2 GOBELETS | Plateau porte 2 gobelets | 225 × 118 mm | 44 mm | 2 gobelets | Gris | 480 |
| 2 | PORTE 4 GOBELETS | Plateau porte 4 gobelets | 217 × 217 mm | 45 mm | 4 gobelets | Gris | 220 |



1

PORTE 2 GOBELETS



2

PORTE 4 GOBELETS

Gobelet conique



n°



| | | | | | | | |
|---|----------------|------------------------------------|---------|-------|--------|-------|----------|
| 1 | GOB 12 CONIQUE | Gobelet conique papier blanc 12 cl | Ø 68 mm | 90 mm | 118 ml | Blanc | 25 × 200 |
|---|----------------|------------------------------------|---------|-------|--------|-------|----------|

Sa forme conique empêche de le poser n'importe où !



1

GOB 12 CONIQUE

Distributeur de gobelets



n°



| | | | | | | | |
|---|-----------------|--------------------------|--------------|---|---|---|---|
| 1 | DISTRIB GOBELET | Distributeur de gobelets | Ø 67 à 74 mm | - | - | - | 1 |
|---|-----------------|--------------------------|--------------|---|---|---|---|



1

DISTRIB GOBELET



Pot à soupe kraft brun



| n° | | | | | | | |
|----|--------------------------|---------------------------------|------------|----------|--------|------|---------|
| 1 | PSA 237 BRUN | Pot carton à soupe brun 237 | Ø 91,1 mm | 59,9 mm | 237 ml | Brun | 20 × 25 |
| 2 | PSA 360 BRUN | Pot carton à soupe brun 360 | Ø 91,1 mm | 84,9 mm | 355 ml | Brun | 20 × 25 |
| 3 | PSA 480 BRUN | Pot carton à soupe brun 480 | Ø 99 mm | 98,8 mm | 473 ml | Brun | 20 × 25 |
| 4 | PSA 780 BRUN | Pot carton à soupe brun 780 | Ø 117,5 mm | 109,4 mm | 780 ml | Brun | 20 × 25 |
| 5 | PSA 960 BRUN | Pot carton à soupe brun 960 | Ø 117,5 mm | 135 mm | 946 ml | Brun | 20 × 25 |
| 6 | COUV PSA 237 ET 360 BRUN | Couvercle pot carton 237 et 360 | Ø 93 mm | 15 mm | – | Brun | 20 × 25 |
| 7 | COUV PSA 480 BRUN | Couvercle pot carton 480 | Ø 100 mm | 17 mm | – | Brun | 20 × 25 |
| 8 | COUV PSA 780 ET 960 BRUN | Couvercle pot carton 780 et 960 | Ø 119 mm | 18 mm | – | Brun | 20 × 25 |



PSA 237 BRUN



PSA 360 BRUN



PSA 480 BRUN



PSA 780 BRUN



PSA 960 BRUN









COUV PSA 237 ET 360 BRUN



COUV PSA 480 BRUN



COUV PSA 780 ET 960 BRUN

| n° |  |  |  |  |  |  |  |
|----|--|--|--|--|--|--|--|
| 1 | PSA 237 | Pot carton à soupe blanc 237 | Ø 91,1 mm | 59,9 mm | 237 ml | Blanc | 20 × 25 |
| 2 | PSA 360 | Pot carton à soupe blanc 360 | Ø 91,1 mm | 84,9 mm | 355 ml | Blanc | 20 × 25 |
| 3 | PSA 480 | Pot carton à soupe blanc 480 | Ø 99 mm | 98,8 mm | 473 ml | Blanc | 20 × 25 |
| 4 | PSA 780 | Pot carton à soupe blanc 780 | Ø 117,5 mm | 109,4 mm | 780 ml | Blanc | 20 × 25 |
| 5 | PSA 960 | Pot carton à soupe blanc 960 | Ø 117,5 mm | 135 mm | 946 ml | Blanc | 20 × 25 |
| 6 | COUV PP 237 ET 360 | Couvercle PP pot carton 237 et 360 | Ø 93 mm | 11 mm | - | Translucide | 20 × 50 |
| 7 | COUV PP 480 | Couvercle PP pot carton 480 | Ø 100 mm | 12 mm | - | Translucide | 20 × 50 |
| 8 | COUV PP 780 ET 960 | Couvercle PP pot carton 780 et 960 | Ø 119 mm | 12 mm | - | Translucide | 20 × 50 |
| 9 | COUV PSA 237 ET 360 | Couvercle pot carton 237 et 360 | Ø 93 mm | 15 mm | - | Blanc | 20 × 25 |
| 10 | COUV PSA 480 | Couvercle pot carton 480 | Ø 100 mm | 17 mm | - | Blanc | 20 × 25 |
| 11 | COUV PSA 780 ET 960 | Couvercle pot carton 780 et 960 | Ø 119 mm | 18 mm | - | Blanc | 20 × 25 |



Pot à soupe blanc



1

PSA 237



2

PSA 360



3

PSA 480



4

PSA 780



5

PSA 960



6

COUV PP 237 ET 360



7

COUV PP 480



8

COUV PP 780 ET 960



9

COUV PSA 237 ET 360



10

COUV PSA 480



11

COUV PSA 780 ET 960

Coque hamburger



n°



| n° | Barcode | Document | Hexagon 1 | Hexagon 2 | Hexagon 3 | Flame | Cube |
|----|---------|--------------------------|--------------|--------------|-----------|-------|---------|
| 1 | BBK 100 | Coque hamburger 100 brun | 130 × 130 mm | 100 × 100 mm | 70 ml | Brun | 6 × 100 |
| 2 | BBK 120 | Coque hamburger 120 brun | 150 × 145 mm | 120 × 116 mm | 70 ml | Brun | 6 × 100 |
| 3 | BBK 155 | Coque hamburger 155 brun | 175 × 120 mm | 155 × 100 mm | 70 ml | Brun | 6 × 100 |
| 4 | BBK 200 | Coque hamburger 200 brun | 240 × 137 mm | 237 × 135 mm | 75 ml | Brun | 3 × 100 |

1



BBK 100

2



BBK 120

3









BBK 155

4



BBK 200

| n° |  |  |  |  |  |  |
|----|--|--|--|--|--|--|
| 1 | BSK 10 | Boîte salade kraft 10 brun + couvercle fenêtre | 95 × 95 mm | 40 mm | Brun | 10 × 25 |
| 2 | BSK 14 | Boîte salade kraft 14 brun + couvercle fenêtre | 140 × 140 mm | 50 mm | Brun | 10 × 50 |
| 3 | BSK 16 | Boîte salade kraft 16 brun + couvercle fenêtre | 160 × 160 mm | 50 mm | Brun | 8 × 60 |
| 4 | BSK 19 | Boîte salade kraft 19 brun + couvercle fenêtre | 190 × 190 mm | 50 mm | Brun | 8 × 40 |



Boîte salade



1

BSK 10



2

BSK 14









3

BSK 16



4

BSK 19

| n° |  |  |  |  |  |  |
|----|---|---|---|---|---|---|
| 1 | TK 07 | Boîte take away 80 brun | 144 × 85 mm | 60 mm | Brun | 5 × 50 |
| 2 | TK 12 | Boîte take away 144 brun | 175 × 105 mm | 65 mm | Brun | 5 × 50 |
| 3 | TK 22 | Boîte take away 190 brun | 228 × 124 mm | 78 mm | Brun | 5 × 50 |



Boîte take away



1

TK 07



2

TK 12



3

TK 22

Barquette rectangulaire



| n° | | | | | | | | |
|----|--------|-------------------------------|--------------|-------------|-------|--------|------|---------|
| 1 | BRK 6 | Barquette rectangulaire kraft | 126 × 95 mm | 86 × 51 mm | 38 mm | 180 ml | Brun | 4 x 250 |
| 2 | BRK 10 | Barquette rectangulaire kraft | 162 × 109 mm | 112 × 64 mm | 40 mm | 300 ml | Brun | 4 x 250 |
| 3 | BRK 13 | Barquette rectangulaire kraft | 168 × 127 mm | 115 × 72 mm | 45 mm | 390 ml | Brun | 2 x 250 |
| 4 | BRK 23 | Barquette rectangulaire kraft | 225 × 147 mm | 136 × 85 mm | 51 mm | 690 ml | Brun | 2 x 250 |
| 5 | BRK 32 | Barquette rectangulaire kraft | 248 × 170 mm | 169 × 94 mm | 60 mm | 960 ml | Brun | 2 x 250 |

1



BRK 6

2



BRK 10

3



BRK 13

4



BRK 23

5



BRK 32

Cornet à frites



| n° | | | | | | |
|----|------------|-----------------------------|-------------|--------|------|----------|
| 1 | CFK SMALL | Cornet à frites small brun | 77 × 125 mm | 90 mm | Brun | 10 × 100 |
| 2 | CFK MEDIUM | Cornet à frites medium brun | 77 × 140 mm | 105 mm | Brun | 10 × 100 |
| 3 | CFK LARGE | Cornet à frites large brun | 87 × 170 mm | 133 mm | Brun | 10 × 100 |

1



CFK SMALL

2









CFK MEDIUM

3



CFK LARGE

| n° |  |  |  |  |  |  |  |
|----|--|--|--|---|--|--|--|
| 1 | BARQ CUIS 500 | Barquette cuisson carton 500 ml | 175 x 130 mm | 60 mm | 500 ml | Blanc + brun | 5 x 50 |
| 2 | BARQ CUIS 750 | Barquette cuisson carton 750 ml | 200 x 150 mm | 60 mm | 750 ml | Blanc + brun | 5 x 50 |



Barquette four

Chaud et froid

Passage au four traditionnel à 220°C pendant 20 minutes et au four micro-onde à 150°C

Enlevez le couvercle de la barquette avant de passer celle-ci au four

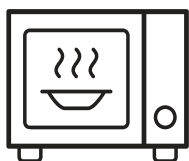

①









BARQ CUIS 500

②



BARQ CUIS 750



| n° |  |  |  |  |  |  |  |
|----|---|---|---|---|---|---|---|
| 1 | FB 050 | Boîte kraft brun 480 ml | 115 × 100 mm | 110 × 90 mm | 45 mm | Brun | 9 × 50 |
| 2 | FB 1 | Boîte kraft brun 780 ml | 130 × 110 mm | 110 × 90 mm | 65 mm | Brun | 9 × 50 |
| 3 | FB 2 | Boîte kraft brun 1500 ml | 215 × 157 mm | 196 × 140 mm | 50 mm | Brun | 4 × 50 |
| 4 | FB 3 | Boîte kraft brun 2000 ml | 210 × 157 mm | 196 × 140 mm | 65 mm | Brun | 4 × 50 |
| 5 | FB 4 | Boîte kraft brun 2950 ml | 224 × 168 mm | 196 × 140 mm | 90 mm | Brun | 4 × 40 |



Food box

①



FB 050

②



FB 1

③



FB 2

④



FB 3

⑤



FB 4

Pot salade kraft brun



n°



| n° | | | | | | | | |
|----|------------------|---|----------|-------|---------|-------------|--------|--|
| 1 | SKB 500 | Pot carton kraft brun PP salade 500 ml | Ø 150 mm | 50 mm | 500 ml | Brun | 6 × 50 | |
| 2 | SKB 780 | Pot carton kraft brun PP salade 780 ml | Ø 150 mm | 61 mm | 780 ml | Brun | 6 × 50 | |
| 3 | SKB 1100 | Pot carton kraft brun PP salade 1100 ml | Ø 166 mm | 65 mm | 1100 ml | Brun | 6 × 50 | |
| 4 | SKB 1250 | Pot carton kraft brun PP salade 1250 ml | Ø 176 mm | 70 mm | 1250 ml | Brun | 6 × 50 | |
| 5 | COUV SKB 780 | Couvercle PET pour SKB 780 & 500 ml | Ø 150 mm | - | - | Cristal | 6 × 50 | |
| 6 | COUV SKB 1100 | Couvercle PET pour SKB 1100 ml | Ø 166 mm | - | - | Cristal | 6 × 50 | |
| 7 | COUV SKB 1250 | Couvercle PET pour SKB 1250 ml | Ø 176 mm | - | - | Cristal | 6 × 50 | |
| 8 | COUV SBL 780 PP | Couvercle PP pour SKB 780 & 500 ml | Ø 150 mm | - | - | Translucide | 6 × 50 | |
| 9 | COUV SBL 1100 PP | Couvercle PP pour SKB 1 100 & 500 ml | Ø 166 mm | - | - | Translucide | 6 × 50 | |
| 10 | COUV SBL 1250 PP | Couvercle PP pour SKB 1 250 & 500 ml | Ø 176 mm | - | - | Translucide | 6 × 50 | |

Chaud et froid

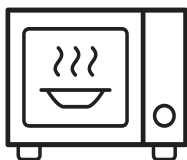

SKB 500



SKB 780



SKB 1100



SKB 1250

5



COUV SKB 780

6



COUV SKB 1100

7



COUV SKB 1250

8



COUV SBL 780 PP

9



COUV SBL 1100 PP

10



COUV SBL 1250 PP

Pot salade blanc



| n° |  |  |  |  |  |  |  |  |  |
|----|---|---|---|---|---|---|---|---|---|
| 1 | SBL 780 | Pot salade carton blanc salade 780 | Ø 150 mm | 61 mm | 780 ml | Blanc | 6 × 50 | | |
| 2 | SBL 1100 | Pot carton carton blanc salade 1100 ml | Ø 166 mm | 65 mm | 1100 ml | Blanc | 6 × 50 | | |
| 3 | SBL 1250 | Pot carton carton blanc salade 1250 ml | Ø 176 mm | 70 mm | 1250 ml | Blanc | 6 × 50 | | |
| 4 | COUV SKB 780 | Couvercle PET pour SKB 500 & 780 ml | Ø 150 mm | - | - | Translucide | 6 × 50 | | |
| 5 | COUV SKB 1100 | Couvercle PET pour SKB 1100 | Ø 166 mm | - | - | Translucide | 6 × 50 | | |
| 6 | COUV SKB 1250 | Couvercle PET pour SKB 1250 | Ø 176 mm | - | - | Translucide | 6 × 50 | | |



Froid



Pot à pâtes blanc



n°



| | | | | | | | | |
|---|-----------------|-------------------|-------------|--------|---------|--------|-------|---------|
| 1 | POT A PATES 480 | Pot à pâtes blanc | 84 × 71 mm | 97 mm | Ø 83 mm | 480 ml | Blanc | 10 × 50 |
| 2 | POT A PATES 780 | Pot à pâtes blanc | 102 × 87 mm | 97 mm | Ø 95 mm | 780 ml | Blanc | 10 × 50 |
| 3 | POT A PATES 960 | Pot à pâtes blanc | 105 × 94 mm | 117 mm | Ø 95 mm | 960 ml | Blanc | 10 × 50 |



1



POT A PATES 480

2



POT A PATES 780

3



POT A PATES 960

Pot wrap blanc



n°



| | | | | | | | | |
|---|--------------------|--------------------------|---------|---------|--------|--------|-------|---------|
| 1 | POT WRAP BLANC 5,5 | Pot wrap blanc 5,5 oz | Ø 84 mm | Ø 60 mm | 120 mm | 165 ml | Blanc | 20 × 50 |
| 2 | GSP49 DPE | Pot wrap blanc double PE | Ø 84 mm | Ø 60 mm | 120 mm | 165 ml | Blanc | 15 × 80 |



1











POT WRAP BLANC 5,5
" FILM PLASTIQUE INTÉRIEUR "

2



GSP49 DPE
" FILM PLASTIQUE INTÉRIEUR ET EXTÉRIEUR "

| n° |  |  |  |  |  |  |  |  |
|----|--|--|--|--|--|--|--|--|
| 1 | POT A PATES 480 KB | Pot à pâtes brun | 84 × 71 mm | 97 mm | Ø 83 mm | 480 ml | Brun | 10 × 50 |
| 2 | POT A PATES 780 KB | Pot à pâtes brun | 102 × 87 mm | 93 mm | Ø 97 mm | 780 ml | Brun | 10 × 50 |
| 3 | POT A PATES 960 KB | Pot à pâtes brun | 105 × 94 mm | 117 mm | Ø 95 mm | 960 ml | Brun | 10 × 50 |



Pot à pâtes kraft



| n° |  |  |  |  |  |  |  |  |
|----|---|---|---|---|---|---|---|---|
| 1 | POT WRAP BRUN 5,5 | Pot wrap brun 5,5 oz | Ø 84 mm | Ø 60 mm | 120 mm | 165 ml | Brun | 20 × 50 |
| 2 | GOB WRAP BRUN DPE | Pot wrap brun double PE | Ø 84 mm | Ø 60 mm | 120 mm | 165 ml | Brun | 24 × 50 |



Pot wrap kraft

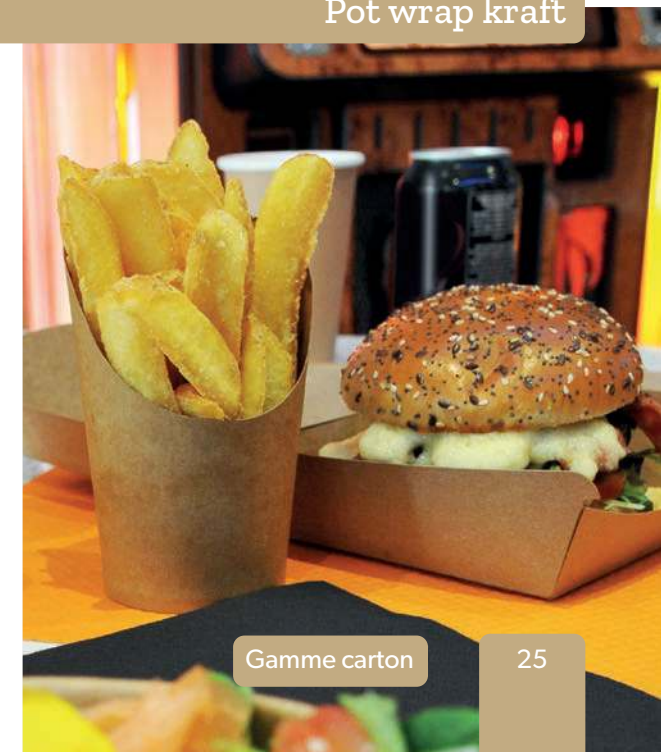

Pot bucket



n°



| n° | Barcode | Description | Ø 190 mm | 147 mm | Ø 180 mm | Ø 148 mm | Capacity | Decor | Quantity |
|----|---------|---|----------|--------|----------|----------|----------|-------|----------|
| 1 | PB 85 | Pot carton bucket 85 oz avec couvercle | Ø 190 mm | 147 mm | Ø 180 mm | Ø 148 mm | 2550 ml | Décor | 6 x 50 |
| 2 | PB 150 | Pot carton bucket 150 oz avec couvercle | Ø 215 mm | 166 mm | Ø 205 mm | Ø 160 mm | 4500 ml | Décor | 4 x 50 |

Nouveau décor !

1



PB 85

2



PB 150

Pot whizz



n°



| n° | Barcode | Description | Ø 84 mm | Ø 61 mm | Ø 136 mm | Capacity | Color | Quantity |
|----|---------------|-----------------------------|---------|---------|----------|----------|-------|----------|
| 1 | POT WHIZZ 325 | Pot whizz avec trous 325 ml | Ø 84 mm | Ø 61 mm | Ø 136 mm | 325 ml | Brun | 20 x 50 |
| 2 | POT WHIZZ 500 | Pot whizz avec trous 480 ml | Ø 86 mm | Ø 61 mm | Ø 171 mm | 480 ml | Brun | 20 x 50 |

1









POT WHIZZ 325

2









POT WHIZZ 500

| n° |  |  |  |  |  |  |
|----|--|--|---|--|--|--|
| 1 | POT PLISSE 30 | Pot papier soufflé 30 ml | Ø 42 mm 29 mm | 30 ml | Blanc | 20 × 250 |
| 2 | POT PLISSE 37 | Pot papier soufflé 37 ml | Ø 48 mm 26 mm | 37 ml | Blanc | 20 × 250 |
| 3 | POT PLISSE 59 | Pot papier soufflé 59 ml | Ø 54 mm 39 mm | 59 ml | Blanc | 20 × 250 |



Pot plissé



| n° |  |  |  |  |  |  |
|----|---|---|--|---|---|---|
| 1 | CGL 100 | Coupe à glace 100 brun | Ø 75 mm 49 mm | 110 ml | Brun | 20 × 50 |
| 2 | CGL 140 | Coupe à glace 140 brun | Ø 86 mm 52 mm | 165 ml | Brun | 20 × 50 |
| 3 | CGL 240 | Coupe à glace 240 brun | Ø 95 mm 62 mm | 240 ml | Brun | 20 × 50 |
| 4 | CGL 350 | Coupe à glace 350 brun | Ø 102 mm 79 mm | 350 ml | Brun | 20 × 50 |
| 5 | DOME CGL 140 | Dôme pour coupe à glace 140 | Ø 87 mm | - | Translucide | 20 × 50 |
| 6 | DOME CGL 240 | Dôme pour coupe à glace 240 | Ø 95 mm | - | Translucide | 20 × 50 |



Coupe à glace, dôme pour coupe à glace



Couvercle plat, nous consulter

Boîte à pizza



n°



| | | | | | | |
|---|---------------------------|--|--------------|-------|----------------|-----|
| - | BTE PIZZA 20 × 20 H40 | Boîte pizza kraft brun 20 × 20 H40 | 200 × 200 mm | 40 mm | Brun + 3 coul. | 100 |
| - | BTE PIZZA 26 × 26 H40 | Boîte pizza kraft brun 26 × 26 H40 | 260 × 260 mm | 40 mm | Brun + 3 coul. | 100 |
| - | BTE PIZZA 29 × 29 H40 | Boîte pizza kraft brun 29 × 29 H40 | 290 × 290 mm | 40 mm | Brun + 3 coul. | 100 |
| - | BTE PIZZA 31 × 31 H40 | Boîte pizza kraft brun 31 × 31 H40 | 310 × 310 mm | 40 mm | Brun + 3 coul. | 100 |
| - | BTE PIZZA 33 × 33 H40 | Boîte pizza kraft brun 33 × 33 H40 | 330 × 330 mm | 40 mm | Brun + 3 coul. | 100 |
| - | BTE PIZZA 34,5 × 34,5 H40 | Boîte pizza kraft brun 34,5 × 34,5 H40 | 345 × 345 mm | 40 mm | Brun + 3 coul. | 100 |
| - | BTE PIZZA 40 × 40 H40 | Boîte pizza kraft brun 40 × 40 H40 | 400 × 400 mm | 40 mm | Brun + 3 coul. | 50 |
| - | BTE PIZZA 50 × 50 H40 | Boîte pizza kraft brun 50 × 50 H40 | 500 × 500 mm | 40 mm | Brun + 3 coul. | 50 |
| - | BTE PIZZA 27 × 17 H75 | Boîte pizza kraft brun calzone 27 × 17 H70 | 270 × 170 mm | 70 mm | Brun + 3 coul. | 200 |





| | | | | | | |
|----|---------------|--------------------|---------|-------|-------|---------|
| n° | | | | | | |
| 1 | TREPIED PIZZA | Trépied pour pizza | Ø 45 mm | 38 mm | Blanc | 5 x 200 |



TREPIED PIZZA

Trépied pizza

Plateau traiteur



| | | | | | | |
|----|----------------------|------------------------------------|--------------|-------|--------|--------|
| 1 | PT 10 × 16 ARGENT | Plateau traiteur argent 10 × 16 cm | 100 × 160 mm | 12 mm | Argent | 50 |
| 2 | PT 10 × 16 OR | Plateau traiteur or 10 × 16 cm | 100 × 160 mm | 12 mm | Or | 50 |
| 3 | PT 14 × 21 ARGENT | Plateau traiteur argent 14 × 21 cm | 140 × 210 mm | 12 mm | Argent | 50 |
| 4 | PT 14 × 21 OR | Plateau traiteur or 14 × 21 cm | 140 × 210 mm | 12 mm | Or | 50 |
| 5 | PT 16 × 22 ARGENT | Plateau traiteur argent 16 × 22 cm | 160 × 220 mm | 12 mm | Argent | 50 |
| 6 | PT 16 × 22 OR | Plateau traiteur or 16 × 22 cm | 160 × 220 mm | 12 mm | Or | 50 |
| 7 | PT 19 × 28 ARGENT 1F | Plateau traiteur argent 19 × 28 cm | 190 × 280 mm | 12 mm | Argent | 4 x 25 |
| 8 | PT 19 × 28 OR 1F | Plateau traiteur or 19 × 28 cm | 190 × 280 mm | 12 mm | Or | 4 x 25 |
| 9 | PT 28 × 42 ARGENT 1F | Plateau traiteur argent 28 × 42 cm | 280 × 420 mm | 12 mm | Argent | 4 x 25 |
| 10 | PT 28 × 42 OR 1F | Plateau traiteur or 28 × 42 cm | 280 × 420 mm | 12 mm | Or | 4 x 25 |

Plateaux traiteur 1 face



PT 10 X 16 ARGENT



PT 14 X 21 ARGENT



PT 16 X 22 ARGENT



PT 19 X 28 ARGENT 1F



PT 28 X 42 ARGENT 1F



PT 10 X 16 OR



PT 14 X 21 OR



PT 16 X 22 OR



PT 19 X 28 OR 1F



PT 28 X 42 OR 1F

n°



Plateau traiteur

| | | | | | | |
|----|-------------------|------------------------------------|--------------|-------|-------------|--------|
| 1 | PT 19 × 28 NOIR | Plateau traiteur noir 19 × 28 cm | 190 × 280 mm | 12 mm | Noir / noir | 4 × 25 |
| 2 | PT 25 × 34 NOIR | Plateau traiteur noir 25 × 34 cm | 250 × 340 mm | 12 mm | Noir / noir | 4 × 25 |
| 3 | PT 28 × 42 NOIR | Plateau traiteur noir 28 × 42 cm | 280 × 420 mm | 12 mm | Noir / noir | 4 × 25 |
| 4 | PT 19 × 28 ARGENT | Plateau traiteur argent 19 × 28 cm | 190 × 280 mm | 12 mm | Argent / or | 4 × 25 |
| 5 | PT 25 × 34 ARGENT | Plateau traiteur argent 25 × 34 cm | 250 × 340 mm | 12 mm | Argent / or | 4 × 25 |
| 6 | PT 28 × 42 ARGENT | Plateau traiteur argent 28 × 42 cm | 280 × 420 mm | 12 mm | Argent / or | 4 × 25 |
| 7 | PT 32 × 42 ARGENT | Plateau traiteur argent 32 × 42 cm | 320 × 420 mm | 12 mm | Argent / or | 4 × 25 |
| 8 | PT 19 × 28 OR | Plateau traiteur or 19 × 28 cm | 190 × 280 mm | 12 mm | Or / argent | 4 × 25 |
| 9 | PT 25 × 34 OR | Plateau traiteur or 25 × 34 cm | 250 × 340 mm | 12 mm | Or / argent | 4 × 25 |
| 10 | PT 28 × 42 OR | Plateau traiteur or 28 × 42 cm | 280 × 420 mm | 12 mm | Or / argent | 4 × 25 |
| 11 | PT 32 × 42 OR | Plateau traiteur or 32 × 42 cm | 320 × 420 mm | 12 mm | Or / argent | 4 × 25 |

Plateaux traiteur 2 faces



1

PT 19 X 28 NOIR



2

PT 25 X 34 NOIR



3

PT 28 × 42 NOIR



4

PT 19 X 28 ARGENT



5

PT 25 X 34 ARGENT



6

PT 28 × 42 ARGENT



7

PT 32 × 42 ARGENT



8

PT 19 X 28 OR



9

PT 25 X 34 OR



10

PT 28 × 42 OR



11

PT 32 × 42 OR

Plateau



| n° | | | | | | |
|----|---------------|--|--------------|-------|-------|----------|
| 1 | PTR 10 × 16 | Plateau rectangulaire 10 × 16 mm | 100 × 160 mm | 12 mm | Blanc | 12 × 250 |
| 2 | PTS 13 × 18 | Plateau rectangulaire snack 13 × 18 × 3 mm | 130 × 180 mm | 30 mm | Blanc | 4 × 250 |
| 3 | PTR 13 × 20 | Plateau rectangulaire 13 × 20 mm | 130 × 200 mm | 12 mm | Blanc | 6 × 250 |
| 4 | PTR 16,5 × 20 | Plateau rectangulaire 16,5 × 20 mm | 165 × 200 mm | 12 mm | Blanc | 4 × 250 |
| 5 | PTR 17,5 × 25 | Plateau rectangulaire 17,5 × 25 mm | 175 × 250 mm | 12 mm | Blanc | 4 × 250 |
| 6 | PTR 20 × 27 | Plateau rectangulaire 20 × 27 mm | 200 × 270 mm | 12 mm | Blanc | 1 × 250 |
| 7 | PTR 23 × 33 | Plateau rectangulaire 23 × 33 mm | 230 × 330 mm | 12 mm | Blanc | 1 × 250 |

1



PTR 10 × 16

2



PTS 13 × 18

3



PTR 13 × 20

4



PTR 16,5 × 20

5



PTR 17,5 × 25

6









PTR 20 × 27

7



PTR 23 × 33

| n° |  |  |  |  |  |  |
|----|--|--|--|--|--|--|
| 1 | BTE LUNCH 20 × 29 | Boîte pâtissière lunch 29 × 20 × 6 cm | 280 × 190 mm | 60 mm | Blanc | 50 |
| 2 | BTE LUNCH 26 × 34 | Boîte pâtissière lunch 34 × 26 × 6 cm | 345 × 258 mm | 60 mm | Blanc | 25 |
| - | BTE LUNCH 28 × 42 | Boîte pâtissière lunch 42 × 28 × 6 cm | 425 × 285 mm | 60 mm | Blanc | 25 |
| 3 | BTE LUNCH 28 × 42 NANO | Boîte lunch 28 × 42 × 6 cm nanocannelure | 280 × 420 mm | 60 mm | Blanc | 100 |
| 4 | BTE LUNCH 32 × 42 | Boîte pâtissière lunch 32 × 42 × 6 cm | 320 × 420 mm | 60 mm | Blanc | 25 |

Boîte lunch



① BTE LUNCH 20 × 29



② BTE LUNCH 26 × 34



③ BTE LUNCH 28 × 42 NANO



④ BTE LUNCH 32 × 42

| n° |  |  |  |  |  |  |
|----|---|---|---|---|---|---|
| 1 | RAINE 11 | Carré rainé 11 | 110 × 110 mm | 20 mm | Blanc | 500 |
| 2 | RAINE 13 | Carré rainé 13 | 130 × 130 mm | 20 mm | Blanc | 500 |
| 3 | RAINE 15 | Carré rainé 15 | 150 × 150 mm | 20 mm | Blanc | 500 |
| 4 | RAINE 17 | Carré rainé 17 | 170 × 170 mm | 20 mm | Blanc | 500 |
| 5 | RAINE 19 | Carré rainé 19 | 190 × 190 mm | 20 mm | Blanc | 500 |
| 6 | PART PIZZA | Plat carton pour part pizza | 190 × 170 mm | 20 mm | Blanc | 250 |
| 7 | PART QUICHE | Plat carton pour part quiche | 170 × 120 mm | 20 mm | Blanc | 250 |



Carré rainé, part pizza, part quiche



RAINE 11



RAINE 13



RAINE 15



RAINE 17



RAINE 19



PART PIZZA



PART QUICHE

Boîte pâtissière blanche



| | | | |
|----------------------|--|--------|-----|
| BTE PAT 14 × 5 | Boîte pâtissière 14 × 14 × 5 | - | 50 |
| BTE 14 × 5 FENETRE | Boîte pâtissière 14 × 14 × 5 à fenêtre | - | 50 |
| BTE PAT 16 × 5 | Boîte pâtissière 16 × 16 × 5 | 8 & 10 | 50 |
| BTE PAT 18 × 5 | Boîte pâtissière 18 × 18 × 5 | 8 & 10 | 50 |
| BTE PAT 20 × 5 | Boîte pâtissière 20 × 20 × 5 | 8 & 10 | 50 |
| BTE PAT 23 × 5 | Boîte pâtissière 23 × 23 × 5 | 8 & 10 | 50 |
| BTE PAT 26 × 5 | Boîte pâtissière 26 × 26 × 5 | 8 & 10 | 50 |
| BTE PAT 29 × 5 | Boîte pâtissière 29 × 29 × 5 | 8 & 10 | 25 |
| BTE PAT 31 × 5 | Boîte pâtissière 31 × 31 × 5 | 8 & 10 | 25 |
| BTE PAT 33 × 5 | Boîte pâtissière 33 × 33 × 5 | 8 & 10 | 25 |
| BTE PAT 35 × 5 | Boîte pâtissière 35 × 35 × 5 | 8 & 10 | 25 |
| BTE PAT 40 × 5 | Boîte pâtissière 40 × 40 × 5 | 8 & 10 | 25 |
| CAIS PAT 16 × 11 × 5 | Caissette 16 × 11 × 5 sans couvercle | - | 100 |
| CAIS PAT 18 × 12 × 5 | Caissette 18 × 12 × 5 sans couvercle | - | 100 |
| BTE PAT 19 × 9 × 8 | Boîte pâtissière 2 bouchées 19 × 9 × 8 | - | 100 |
| BTE PAT 27 × 9 × 8 | Boîte pâtissière 2 bouchées 27 × 9 × 8 | - | 100 |
| BTE REPAS 100 × 180 | Boîte à poignée repas 100 × 180 | - | 50 |
| BTE REPAS 105 × 105 | Boîte à poignée repas 105 × 105 | - | 50 |

Autres formes et dimensions
nous consulter



Boîte pâtissière décor



| | | | |
|----------------------------|--------------------------------------|--------|-----|
| BTE PAT 16 × 5 DECOR | Boîte pâtissière 16 × 16 × 5 décor | 8 | 50 |
| BTE PAT 18 × 5 DECOR | Boîte pâtissière 18 × 18 × 5 décor | 8 | 50 |
| BTE PAT 20 × 5 DECOR | Boîte pâtissière 20 × 20 × 5 décor | 8 & 10 | 50 |
| BTE PAT 23 × 5 DECOR | Boîte pâtissière 23 × 23 × 5 décor | 8 & 10 | 50 |
| BTE PAT 26 × 5 DECOR | Boîte pâtissière 26 × 26 × 5 décor | 8 & 10 | 50 |
| BTE PAT 29 × 5 DECOR | Boîte pâtissière 29 × 29 × 5 décor | 8 & 10 | 50 |
| BTE PAT 33 × 5 DECOR | Boîte pâtissière 33 × 33 × 5 décor | 8 & 10 | 25 |
| BTE PAT 35 × 5 DECOR | Boîte pâtissière 35 × 35 × 5 décor | 8 & 10 | 25 |
| BTE PAT 40 × 5 DECOR | Boîte pâtissière 40 × 40 × 5 décor | 8 & 10 | 25 |
| CAIS PAT 16 × 11 × 5 DECOR | Caissette 16 × 11 × 5 sans couvercle | - | 100 |
| CAIS PAT 18 × 12 × 5 DECOR | Caissette 18 × 12 × 5 sans couvercle | - | 100 |
| CAIS PAT 20 × 13 × 6 DECOR | Caissette 20 × 13 × 6 sans couvercle | - | 100 |
| CAIS PAT 22 × 14 × 6 DECOR | Caissette 22 × 14 × 6 sans couvercle | - | 100 |
| CAIS PAT 24 × 15 × 7 DECOR | Caissette 24 × 15 × 7 sans couvercle | - | 100 |

NEW!

**Autres formes et dimensions,
nous consulter.**

Boîtes pâtisseries hauteur 5 : couleur anis
Boîtes pâtisseries hauteur 8 : couleur rouge
Boîtes pâtisseries hauteur 10 : couleur orange

Sac kraft



| n° | | | | | | |
|----|----------------------|-------------------------------------|--------------|--------|-------|-----|
| 1 | KB 22 × 10 × 28 BL | Sac cabas kraft blanc poignée plate | 220 × 100 mm | 280 mm | Blanc | 250 |
| 2 | KB 26 X 14 X 30 BL | Sac cabas kraft blanc poignée plate | 260 × 140 mm | 300 mm | Blanc | 250 |
| 3 | KB 26 × 20 × 28 BL | Sac cabas kraft blanc poignée plate | 260 × 200 mm | 280 mm | Blanc | 250 |
| 4 | KB 26 × 17 × 25 BL | Sac cabas kraft blanc poignée plate | 260 × 170 mm | 250 mm | Blanc | 250 |
| 5 | KB 32 × 16 × 35 BL | Sac cabas kraft blanc poignée plate | 320 × 160 mm | 350 mm | Blanc | 250 |
| 6 | KB 32 × 22 × 24 BL | Sac cabas kraft blanc poignée plate | 320 × 220 mm | 240 mm | Blanc | 250 |
| 7 | KB 22 × 10 × 28 BRUN | Sac cabas kraft brun poignée plate | 220 × 100 mm | 280 mm | Brun | 250 |
| 8 | KB 26 X 14 X 30 BRUN | Sac cabas kraft brun poignée plate | 260 × 140 mm | 300 mm | Brun | 250 |
| 9 | KB 26 × 20 × 28 BRUN | Sac cabas kraft brun poignée plate | 260 × 200 mm | 280 mm | Brun | 250 |
| 10 | KB 26 × 17 × 25 BRUN | Sac cabas kraft brun poignée plate | 260 × 170 mm | 250 mm | Brun | 250 |
| 11 | KB 32 × 16 × 35 BRUN | Sac cabas kraft brun poignée plate | 260 × 200 mm | 280 mm | Brun | 250 |
| 12 | KB 32 × 22 × 24 BRUN | Sac cabas kraft brun poignée plate | 320 × 220 mm | 240 mm | Brun | 250 |



1

KB 22 × 10 × 28 BL



2

KB 26 X 14 X 30 BL



3

KB 26 × 20 × 28 BL



4

KB 26 × 17 × 25 BL



5

KB 32 × 16 × 35 BL



6

KB 32 × 22 × 24 BL



7

KB 22 × 10 × 28 BRUN



8

KB 26 X 14 X 30 BRUN



9

KB 26 × 20 × 28 BRUN



10

KB 26 × 17 × 25 BRUN



11

KB 32 × 16 × 35 BRUN



12

KB 32 × 22 × 24 BRUN



Personnalisable !

Vous souhaitez vous faire connaître, accroître votre notoriété en véhiculant votre image de marque ?

Le sac publicitaire personnalisable est l'objet publicitaire le plus efficace et durable pour répondre à vos objectifs.

| n° | | | | | | |
|----|-----------------------|---------------------|--------------|--------|-------|-----|
| 1 | SOS 18 × 11 × 35 BL | Sac SOS kraft blanc | 180 × 110 mm | 350 mm | Blanc | 500 |
| 2 | SOS 20 × 16 × 40 BL | Sac SOS kraft blanc | 200 × 160 mm | 400 mm | Blanc | 500 |
| 3 | SOS 18 × 11 × 35 BRUN | Sac SOS kraft brun | 180 × 110 mm | 350 mm | Brun | 500 |
| 4 | SOS 20 × 16 × 40 BRUN | Sac SOS kraft brun | 210 × 160 mm | 400 mm | Brun | 500 |



Sac kraft







Gamme fibre de canne

| | |
|--|----|
| Assiette carrée, bol | 41 |
| Plateau repas, pot à sauce | 42 |
| Coque hamburger | 43 |
| Bol fibre naturelle | 44 |
| Bol carré fibre naturelle | 45 |
| Barquette menu fibre naturelle, gobelet compostable | 46 |
| Paille papier | 47 |

Assiette ronde



nature
& création

| n° |  |  |  |  |  |  |  |  |  |
|----|--|--|--|--|--|--|--|--|--|
| 1 | AFC 155 | Assiette fibre de canne Ø 155 mm | Ø 155 mm | Ø 110 mm | - | 13 mm | - | Blanc | 20 × 50 |
| 2 | AFC 180 | Assiette fibre de canne Ø 175 mm | Ø 175 mm | Ø 125 mm | - | 13 mm | - | Blanc | 20 × 50 |
| 3 | AFC 230 | Assiette fibre de canne Ø 230 mm | Ø 230 mm | Ø 160 mm | - | 15 mm | - | Blanc | 10 × 50 |
| 4 | AFC 260 | Assiette fibre de canne Ø 260 mm | Ø 260 mm | Ø 195 mm | - | 15 mm | - | Blanc | 10 × 50 |
| 5 | AFC 260 OVALE | Assiette fibre de canne Ø 260 × 192 mm ovale | Ø 260 × 192 mm | Ø 190 × 130 mm | - | 17 mm | - | Blanc | 10 × 50 |
| 6 | AFC 260 3 C | Assiette fibre de canne Ø 260 mm 3 compartiments | Ø 260 mm | Ø 195 mm | - | 15 mm | - | Blanc | 10 × 50 |



1

AFC 155



2

AFC 180



3

AFC 230



4

AFC 260



5

AFC 260 OVALE









6

AFC 260 3 C

Assiette carrée

nature
& création

| n° |  |  |  |  |  |  |  |
|----|---|---|---|---|---|---|---|
| 1 | AFC 160 CARREE | Assiette carrée fibre de canne | 160 × 160 mm | 13 mm | Blanc | 10 × 50 | |
| 2 | AFC 200 CARREE | Assiette carrée fibre de canne | 200 × 200 mm | 17 mm | Blanc | 10 × 50 | |
| 3 | AFC 260 CARREE | Assiette carrée fibre de canne | 260 × 260 mm | 20 mm | Blanc | 6 × 50 | |



1

AFC 160 CARREE













2

AFC 200 CARREE



3

AFC 260 CARREE

| n° |  |  |  |  |  |  |  |  |  |  |
|----|--|--|--|--|--|--|--|--|--|--|
| 1 | BFC 350 | Bol fibre de canne Ø 350 mm | Ø 160 mm | Ø 90 mm | Ø 132 mm | 37 mm | 350 ml | Blanc | 20 × 50 | |
| 2 | BFC 500 | Bol fibre de canne Ø 480 mm | Ø 176 mm | Ø 100 mm | Ø 142 mm | 40 mm | 480 ml | Blanc | 20 × 50 | |

Bol



1

BFC 350



2

BFC 500

nature
& création

Plateau repas



| n° | | | | | | |
|----|------------|---|--------------|-------|-------|--------|
| 1 | PF 5C | Plateau repas 5 compartiments | 320 x 225 mm | 36 mm | Blanc | 4 x 50 |
| 2 | COUV PF 5C | Couvercle plateau repas 5 compartiments | 320 x 225 mm | 28 mm | Blanc | 4 x 50 |



①

PF 5C



②

COUV PF 5C

Pot à sauce



| n° | | | | | | | | | |
|----|------------------|---------------------------------------|---------|---------|---|----|-------|-------|---------|
| 1 | POS 6 FC | Pot à sauce 6 cl fibre de canne | Ø 62 mm | Ø 29 mm | - | 29 | 59 ml | Blanc | 40 x 50 |
| 2 | COUV POS 6 FIBRE | Couvercle fibre pour pot à sauce 6 cl | Ø 62 mm | - | - | - | - | Blanc | 40 x 50 |

nature
& création



①

POS 6 FC



②

COUV POS 6 FIBRE

n°



Coque hamburger

| | | | | | | |
|---|--------------------|--------------------------------------|--------------|-------|-------|---------|
| 1 | HP 1 COMPOSTABLE | Coque hamburger HP 1 | 152 × 147 mm | 82 mm | Blanc | 10 x 50 |
| 2 | HP 3 COMPOSTABLE | Coque hamburger HP 3 | 229 × 160 mm | 80 mm | Blanc | 4 x 50 |
| 3 | HP 3/2 COMPOSTABLE | Coque hamburger HP 3 2 compartiments | 250 × 163 mm | 63 mm | Blanc | 10 x 50 |
| 4 | HP 4 COMPOSTABLE | Coque hamburger HP 4 | 238 × 239 mm | 81 mm | Blanc | 5 x 50 |
| 5 | HP 4/2 COMPOSTABLE | Coque hamburger HP 4 2 compartiments | 242 × 206 mm | 65 mm | Blanc | 4 x 50 |
| 6 | HP 4/3 COMPOSTABLE | Coque hamburger HP 4 3 compartiments | 238 × 233 mm | 76 mm | Blanc | 5 x 50 |



①

HP 1 COMPOSTABLE



②

HP 3 COMPOSTABLE



③

HP 3/2 COMPOSTABLE



④

HP 4 COMPOSTABLE



⑤

HP 4/2 COMPOSTABLE



⑥

HP 4/3 COMPOSTABLE

Bol fibre naturelle



n°



| n° | | | | | | |
|----|----------|------------------------------------|------------|---------|---------|--------|
| 1 | BFN 750 | Bol fibre naturelle 750 ml | Ø 204,4 mm | 41,8 mm | Naturel | 6 × 50 |
| 2 | BFN 960 | Bol fibre naturelle 960 ml | Ø 204,4 mm | 59,3 mm | Naturel | 6 × 50 |
| 3 | BFN 1200 | Bol fibre naturelle 1200 ml | Ø 204,4 mm | 70,8 mm | Naturel | 6 × 50 |
| 4 | COUV BFN | Couvercle pour bol fibre naturelle | Ø 204,4 mm | - | Cristal | 6 × 50 |

nature
& création

1



BFN 750

2



BFN 960

3









BFN 1200

4



COUV BFN

| n° |  |  |  |  |  |  |
|----|--|--|--|--|--|--|
| 1 | SCN 750 | Bol carré fibre naturelle 750 ml | 180 × 180 mm | 54 mm | Naturel | 6 × 50 |
| 2 | SCN 960 | Bol carré fibre naturelle 960 ml | 180 × 180 mm | 70 mm | Naturel | 6 × 50 |
| 3 | SCN 1300 | Bol carré fibre naturelle 1300 ml | 180 × 180 mm | 90 mm | Naturel | 6 × 50 |
| 4 | COUV SCN PET | Couvercle PET pour bol carré fibre naturelle | 180 × 180 mm | - | Cristal | 6 × 50 |
| 5 | COUV SCN PP | Couvercle PP pour bol carré fibre naturelle | 180 × 180 mm | - | Translucide | 6 × 50 |



Bol carré fibre naturelle



①

SCN 750



②

SCN 960



③

SCN 1300



④

COUV SCN PET



⑤

COUV SCN PP

Barquette menu fibre naturelle



nature & création

| n° | | | | | | |
|----|--------------|--|------------------|-------|-------------|--------|
| 1 | MENU 1 | Barquette menu 1 comp. fibre naturelle 850 ml | 235 × 131 mm | 46 mm | Naturel | 6 × 50 |
| 2 | MENU 2 | Barquette menu 2 comp. fibre naturelle 850 ml | 235 × 131 mm | 46 mm | Naturel | 6 × 50 |
| 3 | COUV MENU PP | Couvercle pour barquette menu | 216,6 × 131,6 mm | - | Translucide | 6 × 50 |
| 4 | RFN 810 | Barquette rectangulaire fibre naturelle 810 ml | 228,6 × 163 mm | 40 mm | Naturel | 6 × 50 |
| 5 | COUV RFN | Couvercle pour barquette rectangulaire | 230 × 170 mm | - | Cristal | 6 × 50 |



1

MENU 1



2

MENU 2



3

COUV MENU PP



4

RFN 810



5

COUV RFN

Gobelet compostable



nature & création

| n° | | | | | | | | |
|----|--------------|---------------------------|---------|-------|-----------|--------|---------------|---------|
| 1 | GOB 10 GREEN | Gobelet 10 cl compostable | Ø 62 mm | 63 mm | Ø 43,6 mm | 125 ml | Blanc + décor | 40 × 50 |
| 2 | GOB 18 GREEN | Gobelet 18 cl compostable | Ø 70 mm | 72 mm | Ø 48,8 mm | 200 ml | Blanc + décor | 40 × 50 |
| 3 | GOB 24 GREEN | Gobelet 24 cl compostable | Ø 80 mm | 95 mm | Ø 51 mm | 250 ml | Blanc + décor | 20 × 50 |



1

GOB 10 GREEN



2

GOB 18 GREEN



3

GOB 24 GREEN

| n° |  |  |  |  |  |  |  |
|----|--|--|--|--|--|--|--|
| 1 | PKB 150 | Paille papier cocktail noire | Ø 7 mm | 150 mm | Noir | Papier | 28 × 250 |
| 2 | PSB 200 | Paille papier noire | Ø 6 mm | 200 mm | Noir | Papier | 28 × 250 |
| 3 | PSK 200 | Paille papier kraft | Ø 6 mm | 200 mm | Brun | Papier | 28 × 250 |
| 4 | PSW 200 | Paille papier blanche | Ø 6 mm | 200 mm | Blanc | Papier | 28 × 250 |
| 5 | PSC 200 | Paille papier cuillère noire rayée blanc | Ø 8 mm | 200 mm | Noir/Blanc | Papier | 28 × 250 |
| 6 | PSI 200 | Paille papier emballage individuel blanche | Ø 6 mm | 200 mm | Blanc | Papier | 30 × 150 |
| 7 | PSP 200 | Paille smoothie noire | Ø 8 mm | 200 mm | Noir | Papier | 21 × 150 |
| 8 | PBW 200 | Paille bubble tea blanche | Ø 12 mm | 200 mm | Blanc | Papier | 7 × 200 |
| 9 | PFN 220 | Paille flexible noire | Ø 7 mm | 220 mm | Noir | Papier | 16 × 250 |



Paille papier



PKB 150



PSB 200



PSK 200



PSW 200



PSC 200

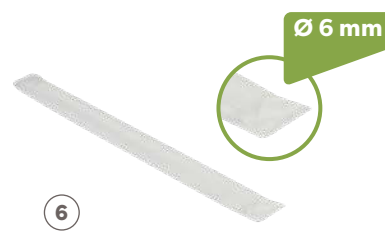

PSI 200



PSP 200



PBW 200



PFN 220





Gamme bois et bambou

| | |
|-------------------------------------|-----------|
| Spatule et pique en bois | 51 |
| Couvert bambou, kit couverts bambou | 52 |
| Pique bambou, ombrelle et palmier | 53 |

Couvert en bois



n°



| n° | Description | Dimensions | Matériau | Emballage |
|----|--|-------------|----------|-----------|
| 1 | FO 165 BOIS Fourchette 165 bois | 155 × 27 mm | Bouleau | 10 × 100 |
| 2 | CO 165 BOIS Couteau 165 bois | 165 × 24 mm | Bouleau | 10 × 100 |
| 3 | CU 165 BOIS Cuillère à soupe 165 bois | 155 × 33 mm | Bouleau | 10 × 100 |
| 4 | CU 110 BOIS Cuillère à dessert 110 bois | 110 × 32 mm | Bouleau | 10 × 100 |
| 5 | CUG 95 BOIS Cuillère à glace bois 95 mm | 95 × 25 mm | Bouleau | 50 × 100 |



1

FO 165 BOIS



2

CO 165 BOIS



3

CU 165 BOIS



4

CU 110 BOIS



5

CUG 95 BOIS

Kit couverts en bois



n°



| n° | Description | Matériau | Emballage |
|----|---|----------|-----------|
| 1 | KIT 2/1 BOIS Kit 2/1 bois (fourchette, couteau) | Bouleau | 250 |
| 2 | KIT 3/1 BOIS Kit 3/1 bois (fourchette, couteau, serviette 1 pli) | Bouleau | 250 |
| 3 | KIT 4/1 BOIS Kit 4/1 bois (3/1 + cuillère dessert 110) | Bouleau | 250 |
| 4 | KIT 6/1 BOIS Kit 6/1 bois (4/1 + sel + poivre) | Bouleau | 250 |
| 5 | CU 110 BOIS INDIV Cuillère dessert 110 mm bois emballée individuellement | Bouleau | 1000 |



1

KIT 2/1 BOIS



2

KIT 3/1 BOIS



3

KIT 4/1 BOIS







4

KIT 6/1 BOIS



5

CU 110 BOIS INDIV

| n° |  |  |  |  |
|----|--|--|--|--|
| 1 | SPAT BD 110 | Spatule bois 11 cm boîte distributrice | Bouleau | 4 × 5000 |
| 2 | MINI BOX | Spatule bois 11 cm boîte distributrice | Bouleau | 10 X 1000 |
| 3 | SPAT 110 PACK | Spatule bois 11 cm pack | Bouleau | 100 X 100 |
| 4 | SPAT BOIS 140 | Spatule bois 14 cm | Bouleau | 10× 1000 |
| 5 | SPAT BOIS 178 | Spatule bois 178 mm | Bouleau | 10 X 1000 |
| 6 | PIQUE 1 POINTE 65 | Pique en bois 1 pointe 65 mm | Bouleau | 48 × 1000 |
| 7 | PIQUE 2 POINTES 65 | Pique en bois 2 pointes 65 mm | Bouleau | 50 × 1000 |
| 8 | PF 85 BOIS | Pique frite bois 85 mm | Bouleau | 10 × 1000 |
| 9 | PIC BOIS INDIV | Pique en bois 2 pointes emballées individuellement | Bouleau | 12 × 1000 |



Spatule et pique en bois



1

SPAT BD 110



2

MINI BOX



3

SPAT 110 PACK



4

SPAT BOIS 140



5

SPAT BOIS 178



6

PIQUE 1 POINTE 65



7

PIQUE 2 POINTES 65



8





PF 85 BOIS



9

PIC BOIS INDIV

Couvert bambou

| n° |  |  |  |  |  |
|----|--|--|--|--|--|
| 1 | FO 170 BAMBOU | Fourchette 170 bambou | 170 mm | Bambou | 40 x 25 |
| 2 | CO 170 BAMBOU | Couteau 170 bambou | 170 mm | Bambou | 40 x 25 |
| 3 | CU 170 BAMBOU | Cuillère à soupe 170 bambou | 170 mm | Bambou | 40 x 25 |
| 4 | CU 110 BAMBOU | Cuillère à dessert 110 bambou | 110 mm | Bambou | 40 x 25 |
| 5 | CU 80 BAMBOU | Cuillère verrine 80 bambou | 80 mm | Bambou | 40 x 25 |



①

FO 170 BAMBOU



②

CO 170 BAMBOU



③

CU 170 BAMBOU



④





CU 110 BAMBOU



⑤

CU 80 BAMBOU

Kit couverts bambou

| n° |  |  |  |  |
|----|--|--|---|---|
| 1 | KIT 2/1 BAMBOU | Kit 2/1 bambou (fourchette, couteau) | Bambou | 250 |
| 2 | KIT 3/1 BAMBOU | Kit 3/1 bambou (fourchette, couteau, serviette 1 pli) | Bambou | 250 |
| 3 | KIT 4/1 BAMBOU | Kit 3/1 bambou (fourchette, couteau, cuillère dessert, serviette 1 pli) | Bambou | 250 |
| 4 | KIT 6/1 BAMBOU | Kit 3/1 bambou (fourchette, couteau, cuillère dessert, serviette 1 pli, sel, poivre) | Bambou | 250 |



①

KIT 2/1 BAMBOU



②

KIT 3/1 BAMBOU







③

KIT 4/1 BAMBOU



④

KIT 6/1 BAMBOU

| n° |  |  |  |  |  |
|----|--|--|--|--|--|
| 1 | PIQUE PLAT 105 | Pique bambou plat 105 mm | 105 × 8 mm | Bambou | 10 × 250 |
| 1 | PIQUE PLAT 150 | Pique bambou plat 150 mm | 150 × 8 mm | Bambou | 10 × 250 |
| 1 | PIQUE PLAT 200 | Pique bambou plat 200 mm | 200 × 8 mm | Bambou | 10 × 250 |
| 2 | PIQUE NŒUD 105 | Pique bambou nœud 105 mm | 105 mm | Bambou | 10 × 250 |
| 3 | PIQUE NŒUD 150 | Pique bambou nœud 150 mm | 150 mm | Bambou | 10 × 250 |
| 4 | PIQUE BROCHETTE 18 | Pique brochette en bois 180 mm | 180 × Ø 3 mm | Bambou | 100 × 100 |
| 5 | PIQUE BROCHETTE 25 | Pique brochette en bois 250 mm | 250 × Ø 3 mm | Bambou | 50 × 200 |
| 6 | PIQUE BROCHETTE 30 | Pique brochette en bois 300 mm | 300 × Ø 3 mm | Bambou | 50 × 200 |



Pique bambou



NEW!

1



PIQUE PLAT 105 / 150 / 200

2



PIQUE NŒUD 105 / 150

3



PIQUE BROCHETTE 18

4





PIQUE BROCHETTE 25

5



PIQUE BROCHETTE 30

| n° |  |  |  |  |  |
|----|---|---|--|---|---|
| 1 | OMBRELLE 10 | Décoration ombrelle colorée 10 cm | 10 cm | Décor | 10 × 144 |
| 1 | OMBRELLE 15 | Décoration ombrelle colorée 15 cm | 15 cm | Décor | 36 × 100 |
| 2 | PALMIER 15 | Décoration palmier en bois 15 cm | 15 cm | Décor | 10 × 100 |



Ombrelle et palmier

1

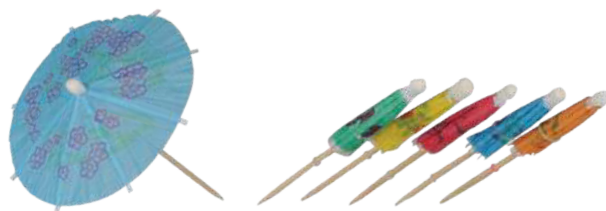

OMBRELLE 10 / 15

2



PALMIER 15







Gamme rouleau aluminium et film étirable alimentaire

| | |
|--------------------------------|----|
| Film alimentaire | 57 |
| Dérouleur Filmacut | 58 |
| Film alimentaire, film cuisson | 60 |
| Dérouleur | 61 |

Rouleau aluminium

| n° |  |  |  |
|----|---|--|--|
| 1 | ALU R200 × 0,20 | Recharge aluminium 200 × 0,20 m | 3 |
| 2 | ALU R200 × 0,29 | Recharge aluminium 200 × 0,29 m | 3 |
| 3 | ALU R200 × 0,325 | Recharge aluminium 200 × 0,325 m | 3 |
| - | ALU R200 × 0,33 FORT 15 µm | Boîte distributrice aluminium épais 200 × 0,33 m | 3 |
| - | ALU R200 × 0,33 FORT 19 µm | Boîte distributrice aluminium épais 200 × 0,33 m | 3 |
| 4 | ALU R200 × 0,44 | Recharge aluminium 200 × 0,44 m | 3 |
| 5 | ALU R200 × 0,50 | Recharge aluminium 200 × 0,50 m | 3 |
| 6 | ALU BD200 × 0,29 | Recharge aluminium 200 × 0,29 m | 6 |
| 7 | ALU BD200 × 0,325 | Recharge aluminium 200 × 0,325 m | 6 |
| 8 | ALU BD200 × 0,44 | Recharge aluminium 200 × 0,44 m | 6 |
| 9 | ALU BD50 × 0,30 | Recharge aluminium 50 × 0,30 m | 24 |



1

ALU R200 × 0,20



2

ALU R200 × 0,29



3

ALU R200 × 0,325



4

ALU R200 × 0,44



5

ALU R200 × 0,50



6

ALU BD200 × 0,29



7

ALU BD200 × 0,325





8

ALU BD200 × 0,44



9

ALU BD50 × 0,30

| n° |  |  |  |
|----|--|--|--|
| 1 | FILM C300 × 0,30 | Boîte distributrice carton 300 × 0,30 m | 6 |
| 2 | FILM C300 × 0,45 | Boîte distributrice carton 300 × 0,45 m | 6 |
| 3 | FILM Z300 × 0,30 | Boîte distributrice carton avec zip 300 × 0,30 m | 6 |
| 4 | FILM Z300 × 0,45 | Boîte distributrice carton avec zip 300 × 0,45 m | 6 |
| 5 | FILM G250 × 0,29 | Boîte distributrice carton green 250 × 0,29 m | 8 |
| 6 | FILM G250 × 0,45 | Boîte distributrice carton green 250 × 0,45 m | 8 |
| 7 | FILM R300 × 0,30 | Recharge film 300 × 0,30 m | 4 |
| 8 | FILM R300 × 0,45 | Recharge film 300 × 0,45 m | 4 |
| - | FILM R300 × 0,60 | Recharge film 300 × 0,60 m | 4 |
| - | FILM R500 × 0,30 | Recharge film 500 × 0,30 m | 4 |
| - | FILM R500 × 0,45 | Recharge film 500 × 0,45 m | 4 |
| - | FILM R1500 × 0,30 | Recharge film 1500 × 0,30 m | 1 |
| - | FILM R1500 × 0,45 | Recharge film 1500 × 0,45 m | 1 |
| 9 | FILM P300 × 0,30 | Boîte plastique 300 × 0,30 m | 6 |
| 10 | FILM P300 × 0,45 | Boîte plastique 300 × 0,45 m | 6 |

Film alimentaire



①

FILM C300 × 0,30



②

FILM C300 × 0,45



③

FILM Z300 × 0,30



④

FILM Z300 × 0,45

NEW!



⑤

FILM G250 × 0,29

NEW!



⑥

FILM G250 × 0,45



⑦

FILM R300 × 0,30



⑧

FILM R300 × 0,45



⑨

FILM P300 × 0,30





⑩

FILM P300 × 0,45

Dérouleur Filmacut



| n° |  |  |  |
|----|---|---|---|
| 1 | FILMACUT 30 | Dérouleur automatique pour film et aluminium 0,30 | 1 |
| 2 | FILMACUT 45 | Dérouleur automatique pour film et aluminium 0,45 | 1 |

NEW!



①

FILMACUT 30

Distributeur universel !

NEW!



②

FILMACUT 45

Distributeur universel !



Aluminium



Film étirable



Film alimentaire

| n° |  |  |  |
|----|---|--|--|
| 9 | FILM ZENIUM | Pour emballage intensif boucherie laize de 300 à 650 m | 1 |
| 10 | BM 30 × 0,30 | Bobineau ménager boîte | 24 |
| - | FILM PRE 15 × 15 | Film prédécoupé 15 × 15 × 500 m | 4 |
| - | FILM PRE 20 × 20 | Film prédécoupé 20 × 20 × 500 m | 4 |
| - | FILM PRE 25 × 25 | Film prédécoupé 25 × 25 × 500 m | 4 |
| - | FILM PRE 30 × 30 | Film prédécoupé 30 × 30 × 500 m | 4 |
| - | FILM PRE 36 × 36 | Film prédécoupé 36 × 36 × 500 m | 4 |
| - | FILM PRE 40 × 40 | Film prédécoupé 40 × 40 × 500 m | 4 |
| - | FILM PRE 46 × 46 | Film prédécoupé 46 × 46 × 500 m | 4 |
| - | FILM PRE 61 × 46 | Film prédécoupé 61 × 46 × 350 m | 4 |
| - | FILM PRE 61 × 81 | Film prédécoupé 61 × 81 × 350 m | 4 |

9



FILM ZENIUM

10



BM 30 × 0,30

Film cuisson

| n° |  |  |  |
|----|--|---|---|
| 1 | FILM BD 50 CUISSON | Film cuisson 50 × 0,50 m (fourni avec liens (48)) | 20 |

Tenue en température : -40° / +200°



1

FILM BD 50 CUISSON

n°



| n° | | | |
|----|-------------------|--|---|
| 1 | DISLAME 30 | Dérouleur métal pour film 0,30 | 1 |
| 2 | DISLAME 45 | Dérouleur métal pour film 0,45 | 1 |
| 3 | DISLAME 60 | Dérouleur métal pour film 0,60 | 1 |
| 4 | DER BAC 30 | Dérouleur plastique pour film 0,30 | 1 |
| 5 | DER BAC 45 | Dérouleur plastique pour film 0,45 | 1 |
| 6 | DER METAL LAME 30 | Dérouleur métal pour film 0,30 | 1 |
| 7 | DER METAL LAME 45 | Dérouleur métal pour film 0,45 | 1 |
| 8 | DER JUM 20/33 | Dérouleur jumelé plastique blanc 0,20 & 0,33 | 1 |



①

DISLAME 30



②

DISLAME 45



③

DISLAME 60



④

DER BAC 30



⑤

DER BAC 45



⑥

DER METAL LAME 30



⑦

DER METAL LAME 45



⑧

DER JUM 20/33

Dérouleur



Gamme aluminium

| | |
|------------------------------------|----|
| Barquette | 65 |
| Godet, coquille | 66 |
| Moule | 67 |
| Plat | 68 |
| Plat à compartiments | 69 |
| Plat gastronomique | 70 |
| Plateau présentation | 72 |
| Coupelle | 73 |
| Tartelette, ramequin et plat ovale | 74 |
| Tourtière | 76 |
| Barquette operculable | 78 |
| Barquette operculable et combo | 80 |
| Barquette plage lisse, cuivrée | 82 |
| Barquette plage lisse | 84 |
| Couvercle barquette plage lisse | 85 |

Assiette



| n° | | | | | | | | | |
|----|--------------|----------|-------|----------|----------|---------|--------|----------|--|
| 1 | AA 138 | Ø 138 mm | 22 mm | Ø 124 mm | Ø 113 mm | 200 ml | Argent | 15 × 100 | |
| 2 | AA 170 | Ø 174 mm | 23 mm | Ø 158 mm | Ø 147 mm | 430 ml | Argent | 10 × 100 | |
| 3 | AS 200 | Ø 200 mm | 22 mm | Ø 185 mm | Ø 145 mm | 430 ml | Argent | 4 × 100 | |
| 4 | FT 2000 | Ø 218 mm | 90 mm | Ø 199 mm | Ø 130 mm | 2239 ml | Argent | 5 × 60 | |
| 5 | COUV FT 2000 | Ø 209 mm | 35 mm | Ø 195 mm | - | - | Argent | 5 × 60 | |

1



AA 138

2



AA 170

3



AS 200

4











FT 2000

5



COUV FT 2000

| n° |  |  |  |  |  |  |  |  |
|----|--|--|--|--|--|--|--|--|
| 1 | BA 150 | 111 × 75 mm | 36 mm | 98 × 62 mm | 80 × 44 mm | 145 ml | Argent | 28 × 100 |
| 2 | BA 250 | 129 × 87 mm | 40 mm | 114 × 72 mm | 96 × 54 mm | 225 ml | Argent | 9 × 100 |
| 3 | BA 350 | 140 × 98 mm | 45 mm | 125 × 83 mm | 107 × 65 mm | 350 ml | Argent | 8 × 100 |
| 4 | BA 500 | 147 × 121 mm | 40 mm | 133 × 108 mm | 116 × 91 mm | 450 ml | Argent | 15 × 100 |
| 5 | BA 502 | 150 × 124 mm | 44 mm | 136 × 112 mm | 106 × 81 mm | 490 ml | Argent | 16 × 100 |
| 6 | BA 750 | 201 × 137 mm | 45 mm | 190 × 120 mm | 160 × 95 mm | 825 ml | Argent | 10 × 100 |
| 7 | BA 911 | 203 × 138 mm | 50 mm | 186 × 121 mm | 161 × 96 mm | 890 ml | Argent | 7 × 100 |



Barquette



Godet



| n° | | | | | | | | | |
|----|----------------|----------|-------|----------|---------|--------|-------------|----------|--|
| 1 | GODET CHOCO | Ø 31 mm | 15 mm | Ø 31 mm | Ø 25 mm | - | Or | 1000 | |
| 2 | GO 13 | Ø 34 mm | 24 mm | Ø 28 mm | Ø 24 mm | 14 ml | Argent | 2500 | |
| 3 | GO 85 | Ø 75 mm | 34 mm | Ø 65 mm | Ø 56 mm | 90 ml | Argent | 10 × 100 | |
| 4 | GO 105 | Ø 72 mm | 41 mm | Ø 64 mm | Ø 53 mm | 109 ml | Argent | 10 × 100 | |
| 5 | GO 110 | Ø 80 mm | 35 mm | Ø 70 mm | Ø 56 mm | 110 ml | Argent | 20 × 100 | |
| 6 | BLISTER GO 110 | Ø 80 mm | 5 mm | - | - | - | Translucide | 20 × 100 | |
| 7 | GO 125 | Ø 85 mm | 41 mm | Ø 76 mm | Ø 60 mm | 150 ml | Argent | 15 × 100 | |
| 8 | BLISTER GO 125 | Ø 87 mm | 10 mm | - | - | - | Translucide | 10 × 100 | |
| 9 | GO 250 | Ø 126 mm | 34 mm | Ø 110 mm | Ø 87 mm | 250 ml | Argent | 15 × 100 | |
| 10 | CD ARGENT | Ø 88 mm | 10 mm | Ø 70 mm | Ø 60 mm | 32 ml | Argent | 12 × 250 | |



GODET CHOCO



GO 13



GO 85



GO 105



GO 110



BLISTER GO 110



GO 125



BLISTER GO 125



GO 250



CD ARGENT

Coquille











| n° | | | | | | | | | |
|----|---------------|--------------|-------|----------|---|--------|-------------|----------|--|
| 1 | COQUILLE | Ø 123 mm | 20 mm | Ø 113 mm | - | 135 ml | Argent | 10 × 100 | |
| 2 | DOME COQUILLE | 126 × 123 mm | 20 mm | - | - | - | Translucide | 10 × 100 | |



COQUILLE



DOME COQUILLE

| n° |  |  |  |  |  |  |  |  |
|----|--|--|--|--|--|--|--|--|
| 1 | MO 140 | 100 × 64 mm | 40 mm | 91 × 55 mm | 74 × 38 mm | 160 ml | Argent | 20 × 100 |
| 2 | MO 550 | 188 × 88 mm | 50 mm | 176 × 76 mm | 157 × 57 mm | 550 ml | Argent | 15 × 100 |
| 3 | MO 600 × 53 | 206 × 86 mm | 51 mm | 192 × 72 mm | 175 × 55 mm | 600 ml | Argent | 16 × 100 |
| 4 | MO 600 × 60 | 175 × 95 mm | 60 mm | 160 × 80 mm | 139 × 59 mm | 595 ml | Argent | 10 × 100 |
| 5 | MO 870 | 230 × 100 mm | 58 mm | 217 × 87 mm | 193 × 62 mm | 870 ml | Argent | 10 × 100 |
| 6 | MO 1100 | 232 × 107 mm | 60 mm | 220 × 94 mm | 199 × 73 mm | 1050 ml | Argent | 5 × 100 |
| 7 | MO 1600 | 247 × 133 mm | 68 mm | 234 × 119 mm | 206 × 91 mm | 1640 ml | Argent | 6 × 50 |
| 8 | MO 2000 | 246 × 126 mm | 92 mm | 235 × 115 mm | 202 × 82 mm | 1960 ml | Argent | 3 × 100 |
| 9 | MO 2300 | 305 × 117 mm | 81 mm | 291 × 103 mm | 270 × 82 mm | 2270 ml | Argent | 6 × 50 |
| 10 | MO 3000 | 292 × 143 mm | 95 mm | 278 × 129 mm | 245 × 96 mm | 2800 ml | Argent | 3 × 100 |



Moule

1



MO 140

2



MO 550

3



MO 600 × 53

4



MO 600 × 60

5



MO 870

6



MO 1100

7



MO 1600

8



MO 2000

9



MO 2300

10











MO 3000



| n° | | | | | | | | | | |
|----|--------------------|------------------|-------|--------------|--------------|---------|--------|----------|--|--|
| 1 | PL 300 | 159 × 109 mm | 26 mm | 144 × 94 mm | 132 × 82 mm | 310 ml | Argent | 20 × 100 | | |
| 2 | PL 410 | 178 × 115 mm | 30 mm | 159 × 100 mm | 147 × 89 mm | 380 ml | Argent | 13 × 100 | | |
| 3 | PL 450 / BA 450 | 159 × 109 mm | 38 mm | 144 × 94 mm | 127 × 77 mm | 430 ml | Argent | 20 × 100 | | |
| 4 | OP PL 450 / BA 450 | 160 × 110 mm | - | - | - | - | Argent | 5 × 400 | | |
| 5 | PL 500 | 202 × 137 mm | 25 mm | 188 × 123 mm | 175 × 110 mm | 500 ml | Argent | 10 × 100 | | |
| 6 | PL 600 | 219,5 × 143,5 mm | 29 mm | 200 × 124 mm | 170 × 94 mm | 560 ml | Argent | 12 × 100 | | |
| 7 | PL 650 | 206 × 138 mm | 28 mm | 193 × 125 mm | 176 × 108 mm | 610 ml | Argent | 12 × 100 | | |
| 8 | PL 1001 | 232 × 142 mm | 42 mm | 227 × 137 mm | 201 × 111 mm | 950 ml | Argent | 9 × 100 | | |
| 9 | PL 2200 | 312 × 211 mm | 43 mm | 296 × 195 mm | 278 × 177 mm | 2250 ml | Argent | 4 × 50 | | |
| 10 | PPZ 275 | 444 × 324 mm | 25 mm | 430 × 310 mm | 412 × 292 mm | 2750 ml | Argent | 120 | | |
| 11 | PF 5000 | 398 × 338 mm | 49 mm | 368 × 308 mm | 345 × 285 mm | 5144 ml | Argent | 120 | | |



| n° |  |  |  |  |  |  |  |  |
|----|--|--|--|--|--|--|--|--|
| 1 | PC 1 | 227 × 177 mm | 30 mm | 213 × 162 mm | 197 × 147 mm | 930 ml | Argent | 10 × 100 |
| 2 | PC 1 HAUTE | 227 × 177 mm | 38,5 mm | 213 × 162 mm | 197 × 147 mm | 1150 ml | Argent | 10 × 100 |
| 3 | PC 2 | 227 × 177 mm | 30 mm | 214 × 164 mm | 196 × 147 mm | 515 + 355 ml | Argent | 10 × 100 |
| 4 | PC 2 HAUTE | 227 × 177 mm | 38 mm | 214 × 165 mm | 191 × 141 mm | 415 + 550 ml | Argent | 10 × 100 |
| 5 | PC 3 | 227 × 177 mm | 30 mm | 213 × 162 mm | 197 × 147 mm | 220 + 160 + 380 ml | Argent | 10 × 100 |
| 6 | PC 3 HAUTE | 227 × 177 mm | 39 mm | 213 × 163 mm | 189 × 142 mm | 360 + 230 + 170 ml | Argent | 5 × 100 |
| 7 | DOME PC | 227 × 177 mm | 10 mm | - | - | - | Transparent | 4 x 125 |
| 8 | OP PC | 227 × 177 mm | 12 mm | - | - | - | Argent | 10 × 100 |
| 9 | PC 2 RIS | 227 × 177 mm | 30 mm | 213 × 163 mm | 196 × 146 mm | 504 + 355 ml | Argent | 4 × 100 |
| 10 | PC 3 RIS | 227 × 177 mm | 30 mm | 213 × 163 mm | 197 × 147 mm | 380 + 220 + 160 ml | Argent | 4 × 100 |
| 11 | CO PC | 227 × 177 mm | - | - | - | - | Blanc/Argent | 4 × 100 |



Plat à compartiments



1

PC 1



2

PC 1 HAUTE



3

PC 2



4

PC 2 HAUTE



5

PC 3



6

PC 3 HAUTE



7

DOME PC



8

OP PC



9

PC 2 RIS



10

PC 3 RIS



11

CO PC

Plat gastronorme



| n° | | | | | | | | | |
|----|-------------|--------------|---------|--------------|--------------|---------|--------|---------|--|
| 1 | 1/4 PG 1150 | 263 × 160 mm | 40 mm | 244 × 141 mm | 224 × 121 mm | 1170 ml | Argent | 8 × 100 | |
| 2 | 1/4 PG 1500 | 263 × 160 mm | 55,5 mm | 244 × 141 mm | 216 × 113 mm | 1570 ml | Argent | 8 × 100 | |
| 3 | 1/3 PG 1900 | 321 × 173 mm | 43 mm | 299 × 151 mm | 279 × 131 mm | 1700 ml | Argent | 500 | |
| 4 | 1/2 PG 2400 | 322 × 262 mm | 40 mm | 298 × 238 mm | 278 × 218 mm | 2625 ml | Argent | 100 | |
| 5 | 1/2 PG 3000 | 322 × 262 mm | 50 mm | 298 × 238 mm | 273 × 213 mm | 3260 ml | Argent | 6 × 50 | |
| 6 | 1/2 PG 3500 | 322 × 262 mm | 60 mm | 298 × 238 mm | 262 × 200 mm | 3600 ml | Argent | 100 | |
| 7 | 1/2 PG 5200 | 324 × 264 mm | 102 mm | 298 × 239 mm | 241 × 181 mm | 5200 ml | Argent | 100 | |
| 8 | OP 1/2 PG | 325 × 265 mm | 15 mm | - | - | - | Argent | 100 | |



1

1/4 PG 1150



2

1/4 PG 1500



3

1/3 PG 1900



4

1/2 PG 2400



5

1/2 PG 3000



6

1/2 PG 3500







7

1/2 PG 5200



8

OP 1/2 PG

| n° |  |  |  |  |  |  |  |  |
|----|--|--|--|--|--|--|--|--|
| 1 | 1/1 PG 5350 | 525 × 325 mm | 36 mm | 496 × 296 mm | 470 × 270 mm | 5000 ml | Argent | 50 |
| 2 | 1/1 PG 6800 | 525 × 325 mm | 50 mm | 496 × 295 mm | 463 × 262 mm | 6500 ml | Argent | 50 |
| 3 | 1/1 PG 8850 | 525 × 325 mm | 67 mm | 496 × 296 mm | 455 × 255 mm | 8850 ml | Argent | 50 |
| 4 | 1/1 PG 11450 | 525 × 325 mm | 80 mm | 496 × 295 mm | 446 × 246 mm | 11450 ml | Argent | 50 |
| 5 | OP 1/1 PG | 525 × 325 mm | 18 mm | - | - | - | Argent | 50 |



Plat gastronorme



1

1/1 PG 5350



2

1/1 PG 6800



3

1/1 PG 8850



4

1/1 PG 11450



5

OP 1/1 PG

Plateau présentation



n°



| | | | | | | | |
|---|-------------|--------------|---------|--------------|--------------|--------|---------|
| 1 | ETUI PP 350 | 360 × 250 mm | 80 mm | - | - | Décor | 100 |
| 1 | ETUI PP 450 | 460 × 310 mm | 80 mm | - | - | Décor | 50 |
| 1 | ETUI PP 550 | 550 × 375 mm | 80 mm | - | - | Décor | 50 |
| 2 | PP 350 | 345 × 250 mm | 23 mm | 319 × 227 mm | 244 × 148 mm | Argent | 10 × 10 |
| 3 | PP 450 | 430 × 286 mm | 25 mm | 400 × 263 mm | 325 × 188 mm | Argent | 10 × 10 |
| 4 | PP 550 | 545 × 372 mm | 27 mm | 508 × 334 mm | 410 × 235 mm | Argent | 5 × 10 |
| 5 | PP 37 × 28 | 375 × 280 mm | 17,5 mm | 370 × 278 mm | 330 × 235 mm | Argent | 5 × 10 |
| 6 | PPR 355 | 354 × 249 mm | 25 mm | 330 × 221 mm | 260 × 158 mm | Argent | 100 |



1

ETUI PP



2

PP 350



3

PP 450



4

PP 550



5







PP 37 × 28



6

PPR 355



| n° |  |  |  |  |  |  |  |  |  |
|----|---|---|---|---|---|---|---|---|---|
| 1 | CE 46 | Ø 66 mm | 19 mm | Ø 58 mm | Ø 50 mm | 46 ml | Or | 5300 | |
| 2 | CE 52 | Ø 52 mm | 32 mm | Ø 46 mm | Ø 38 mm | 46 ml | Or | 5550 | |
| 3 | SRO 050 | Ø 64 mm | 26 mm | Ø 55 mm | Ø 49 mm | 54 ml | Or | 6000 | |
| 4 | SRO 104 | Ø 80 mm | 30,5 mm | Ø 70 mm | Ø 61 mm | 100 ml | Or | 15 x 280 | |



1

CE 46



2

CE 52



3

SRO 050



4

SRO 104

Tartelette



| n° | | | | | | | | |
|----|----------|----------|-------|----------|---------|--------|--------|----------|
| 1 | TA 50 | Ø 50 mm | 15 mm | Ø 44 mm | Ø 35 mm | 18 ml | Argent | 15 x 140 |
| 2 | TA 66 | Ø 66 mm | 21 mm | Ø 60 mm | Ø 40 mm | 40 ml | Argent | 9500 |
| 3 | TA 83 | Ø 83 mm | 17 mm | Ø 78 mm | Ø 54 mm | 50 ml | Argent | 20 x 100 |
| 4 | TA 93 | Ø 93 mm | 18 mm | Ø 84 mm | Ø 61 mm | 70 ml | Argent | 20 x 100 |
| 5 | TA 95 | Ø 100 mm | 17 mm | Ø 90 mm | Ø 70 mm | 87 ml | Argent | 20 x 100 |
| 6 | TA 111 | Ø 112 mm | 17 mm | Ø 104 mm | Ø 79 mm | 125 ml | Argent | 24 x 100 |
| 7 | MO 70/29 | Ø 70 mm | 30 mm | Ø 58 mm | Ø 43 mm | 70 ml | Argent | 24 x 250 |

1



TA 50

2



TA 66

3



TA 83

4



TA 93

5



TA 95

6



TA 111

7



MO 70/29

Ramequin et plat ovale



| n° | | | | | | | | |
|----|--------|-------------|-------|-------------|-------------|--------|--------|----------|
| 1 | RA 100 | Ø 81 mm | 26 mm | Ø 70 mm | Ø 64 mm | 84 ml | Argent | 10 x 100 |
| 2 | RA 176 | Ø 93 mm | 36 mm | Ø 86 mm | Ø 76 mm | 176 ml | Argent | 18 x 100 |
| 3 | RA 251 | Ø 107 mm | 39 mm | Ø 100 mm | Ø 87 mm | 251 ml | Argent | 10 x 100 |
| 4 | RO 251 | 122 x 89 mm | 40 mm | 116 x 83 mm | 106 x 73 mm | 260 ml | Argent | 15 x 100 |

1



RA 100

2



RA 176

3



RA 251

4



RO 251











Tourtière



| n° | | | | | | | | | |
|----|--------|-----------|-------|----------|----------|--------|--------|----------|--|
| 1 | TO 92 | Ø 92,5 mm | 17 mm | Ø 82 mm | Ø 78 mm | 85 ml | Argent | 16 × 100 | |
| 2 | TO 99 | Ø 100 mm | 18 mm | Ø 89 mm | Ø 80 mm | 100 ml | Argent | 15 × 100 | |
| 3 | TO 109 | Ø 109 mm | 21 mm | Ø 100 mm | Ø 90 mm | 160 ml | Argent | 24 × 100 | |
| 4 | TO 138 | Ø 138 mm | 20 mm | Ø 124 mm | Ø 113 mm | 220 ml | Argent | 15 × 100 | |
| 5 | TO 170 | Ø 174 mm | 23 mm | Ø 158 mm | Ø 147 mm | 400 ml | Argent | 12 × 100 | |
| 6 | TO 195 | Ø 195 mm | 25 mm | Ø 180 mm | Ø 170 mm | 582 ml | Argent | 8 × 100 | |



| n° |  |  |  |  |  |  |  |  |
|----|--|--|--|--|--|--|--|--|
| 7 | TO 214 | Ø 214 mm | 18 mm | Ø 201 mm | Ø 184 mm | 550 ml | Argent | 10 × 100 |
| 8 | TO 247 | Ø 247 mm | 24 mm | Ø 230 mm | Ø 217 mm | 865 ml | Argent | 4 × 100 |
| 9 | TO 270 | Ø 277 mm | 23 mm | Ø 260 mm | Ø 249 mm | 1150 ml | Argent | 6 × 100 |
| 10 | TO 327 | Ø 328 mm | 15 mm | Ø 316 mm | Ø 313 mm | 935 ml | Argent | 200 |
| 11 | TO 327 H 22 | Ø 329,5 mm | 20 mm | Ø 314 mm | Ø 304,7 mm | 1690 ml | Argent | 2 × 175 |
| 12 | TO 109 H | Ø 111 mm | 31 mm | Ø 98 mm | Ø 87 mm | 200 ml | Argent | 20 × 100 |
| 13 | TO 200 H | Ø 200 mm | 38 mm | Ø 189 mm | Ø 167 mm | 950 ml | Argent | 4 × 100 |
| 14 | TO 230 H | Ø 228 mm | 39 mm | Ø 215 mm | Ø 197 mm | 1360 ml | Argent | 6 × 100 |
| 15 | TO 284 H | Ø 288 mm | 41 mm | Ø 268 mm | Ø 249 mm | 2160 ml | Argent | 5 × 100 |



Tourtière



Versions perforées disponibles, nous consulter.



TO 214



TO 247



TO 270



TO 327



TO 327 H 22



TO 109 H



TO 200 H



TO 230 H



TO 284 H

Barquette operculaire

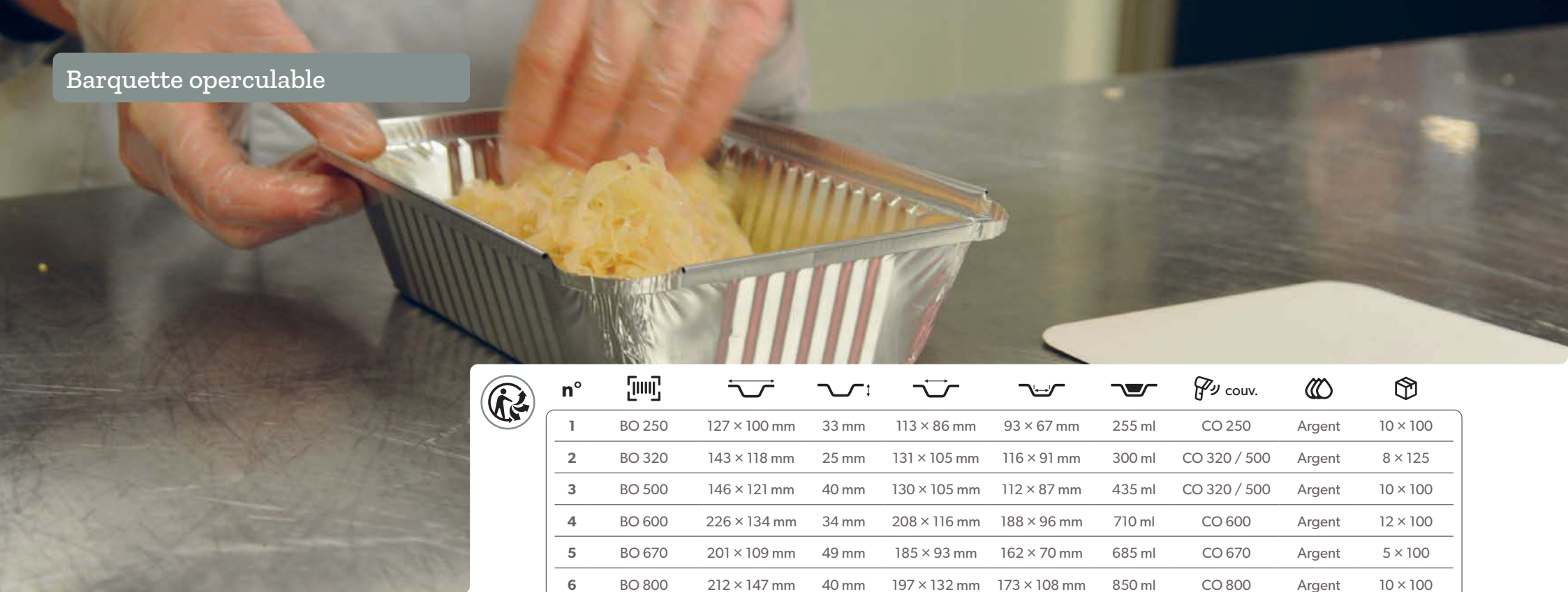

n°



couv.



| | | | | | | | | | |
|---|--------|--------------|-------|--------------|--------------|--------|--------------|--------|----------|
| 1 | BO 250 | 127 × 100 mm | 33 mm | 113 × 86 mm | 93 × 67 mm | 255 ml | CO 250 | Argent | 10 × 100 |
| 2 | BO 320 | 143 × 118 mm | 25 mm | 131 × 105 mm | 116 × 91 mm | 300 ml | CO 320 / 500 | Argent | 8 × 125 |
| 3 | BO 500 | 146 × 121 mm | 40 mm | 130 × 105 mm | 112 × 87 mm | 435 ml | CO 320 / 500 | Argent | 10 × 100 |
| 4 | BO 600 | 226 × 134 mm | 34 mm | 208 × 116 mm | 188 × 96 mm | 710 ml | CO 600 | Argent | 12 × 100 |
| 5 | BO 670 | 201 × 109 mm | 49 mm | 185 × 93 mm | 162 × 70 mm | 685 ml | CO 670 | Argent | 5 × 100 |
| 6 | BO 800 | 212 × 147 mm | 40 mm | 197 × 132 mm | 173 × 108 mm | 850 ml | CO 800 | Argent | 10 × 100 |

1



BO 250

2



BO 320

3



BO 500

4



BO 600

5













BO 670

6



BO 800

| n° |  |  |  |  |  |  |  |  couv. |  |  |
|----|--|--|--|--|--|---|--|--|--|--|
| 7 | BO 900 | 218 × 155 mm | 38 mm | 202 × 139 mm | 180 × 117 mm | 910 ml | CO 900 / 1100 | Argent | 4 × 100 | |
| 8 | BO 930 | 217 × 112 mm | 54 mm | 203 × 98 mm | 184 × 78 mm | 900 ml | CO 930 | Argent | 12 × 100 | |
| 9 | BO 980 | 201 × 136 mm | 50 mm | 186 × 121 mm | 161 × 96 mm | 900 ml | CO 980 | Argent | 10 × 100 | |
| 10 | BO 1100 | 218 × 155 mm | 46 mm | 202 × 139 mm | 177 × 114 mm | 1070 ml | CO 900 / 1100 | Argent | 4 × 100 | |
| 11 | BO 1150 | 263 × 160 mm | 40 mm | 244 × 141 mm | 224 × 121 mm | 1170 ml | CO 1150 / 1500 | Argent | 4 × 100 | |
| 12 | BO 1200 | 242 × 191 mm | 36 mm | 218 × 167 mm | 199 × 149 mm | 1200 ml | CO 1200 | Argent | 4 × 100 | |



Barquette operculable



7

BO 900



8

BO 930



9

BO 980



10

BO 1100



11

BO 1150



12

BO 1200

Barquette operculable et combo



| n° | | | | | | | couv. | | |
|----|--|--------------|---------|--------------|--------------|---------|----------------|--------|---------|
| 13 | BO 1500 | 263 × 160 mm | 56 mm | 244 × 141 mm | 216 × 113 mm | 1570 ml | CO 1150 / 1500 | Argent | 4 × 100 |
| 14 | BO 1500 HAUTE | 250 × 134 mm | 70 mm | 235 × 118 mm | 205 × 86 mm | 1500 ml | CO 1500 H | Argent | 8 × 100 |
| 15 | BO 1900 | 260 × 190 mm | 56,5 mm | 240 × 170 mm | 218 × 148 mm | 2000 ml | CO 1900 | Argent | 4 × 100 |
| 16 | BO 2200 | 315 × 215 mm | 42 mm | 295 × 195 mm | 272 × 172 mm | 2100 ml | CO 2200 | Argent | 4 × 50 |
| 17 | BO 2400 | 314 × 254 mm | 43 mm | 298 × 238 mm | 279 × 219 mm | 2400 ml | CO 2400 | Argent | 6 × 50 |
| 18 | BO 3000 | 319 × 259 mm | 50 mm | 300 × 240 mm | 272 × 212 mm | 3080 ml | CO 2400 | Argent | 6 × 50 |
| 19 | BO 3500 | 320 × 260 mm | 60 mm | 298 × 238 mm | 263 × 203 mm | 3650 ml | CO 2400 | Argent | 300 |
| 20 | COUVERCLE CARTON / ALUMINIUM – RÉFÉRENCE CO POUR BARQUETTE OPERCULABLE | | | | | | | | |

13



BO 1500

14



BO 1500 HAUTE

15



BO 1900

16



BO 2200

17



BO 2400

18



BO 3000

19











BO 3500

20



COUVERCLE CARTON / ALUMINIUM
RÉF. CO POUR BARQUETTE OPERCULABLE



| n° |  |  |  |  |  |  |  |  |  |
|---------|---|---|---|---|---|---|---|---|---|
| COMBO 1 | | BO 500 + CO 500 | 147 × 122 mm | 40 mm | 130 × 105 mm | 113 × 83 mm | 430 ml | Argent | 10 × 100 |
| COMBO 2 | | BO 670 + CO 670 | 201 × 109 mm | 49 mm | 185 × 93 mm | 162 × 70 mm | 685 ml | Argent | 10 × 100 |
| COMBO 3 | | BO 930 + CO 930 | 218 × 114 mm | 60 mm | 204 × 98 mm | 180 × 76 mm | 1000 ml | Argent | 6 × 100 |
| COMBO 4 | | BO 1500 H + CO 1500 H | 250 × 134 mm | 68 mm | 234 × 115 mm | 206 × 86 mm | 1500 ml | Argent | 4 × 100 |

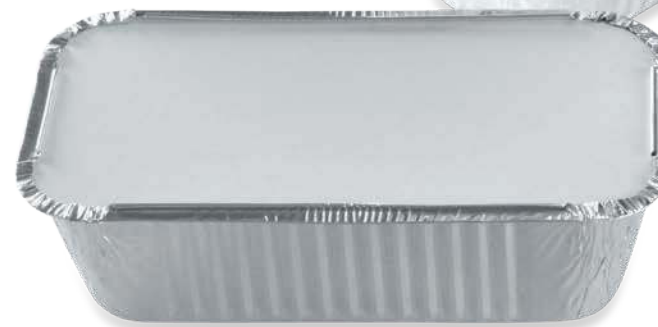

COMBO

Barquette plage lisse, cuivrée



| n° | | | | | | | | | |
|----|----------------|--------------|-------|--------------|------------------|---------|---------------|---------|--|
| 1 | EURO 2000 | 293 × 193 mm | 46 mm | 279 × 179 mm | 266,4 × 166,4 mm | 2000 ml | Argent | 3 × 150 | |
| 2 | PG 2400 RIGIDE | 325 × 265 mm | 43 mm | 302 × 240 mm | 290 × 230 mm | 2800 ml | Argent | 200 | |
| 3 | PG 3200 RIGIDE | 325 × 265 mm | 55 mm | 302 × 240 mm | 285 × 225 mm | 3528 ml | Argent | 170 | |
| 4 | PG 3500 RIGIDE | 325 × 265 mm | 65 mm | 302 × 240 mm | 282 × 222 mm | 4250 ml | Argent | 172 | |
| 5 | SMARTIE | 368 × 247 mm | 48 mm | 324 × 228 mm | 304 × 206 mm | 3150 ml | Argent | 100 | |
| 6 | SMARTIE HAUTE | 368 × 249 mm | 59 mm | 323 × 228 mm | 296 × 201 mm | 4000 ml | Argent/Cuivre | 100 | |



1

EURO 2000



2

PG 2400 RIGIDE



3

PG 3200 RIGIDE



4

PG 3500 RIGIDE



5

SMARTIE











6

SMARTIE HAUTE



Barquette plage lisse

| n° |  |  |  |  |  |  |  |  |
|----|--|--|--|--|--|--|--|--|
| 1 | PLR 500 | 159 x 120 | 48 | 143 x 104 | 128 x 89 | 500 | argent | 12 x 50 |
| 2 | PLR 780 | 178 x 136 | 45 | 164 x 122 | 152 x 110 | 780 | argent | 12 x 50 |
| 3 | PLR 1000 | 220 x 150 | 44 | 202 x 132 | 190 x 120 | 1000 | argent | 15 x 50 |
| 4 | PLR 1500 | 239 x 167 | 50 | 220 x 148 | 207 x 135 | 1500 | argent | 6 x 50 |
| 5 | PGR 1500 | 265 x 162 | 45 | 247 x 144 | 233,8 x 130,8 | 1500 | argent | 6 x 50 |
| 6 | PLR 780 NOIR | 178 x 136 | 45 | 164 x 122 | 152 x 110 | 780 | noir | 12 x 50 |
| 7 | PLR 1000 NOIR | 220 x 150 | 44 | 202 x 132 | 190 x 120 | 1000 | noir | 15 x 50 |
| 8 | EURO 2000 NOIR | 293 x 193 | 46 | 279 x 179 | 266,4 x 166,4 | 2000 | noir | 3 x 150 |

1



PLR 500

2



PLR 780

3



PLR 1000

4



PLR 1500

5



PGR 1500

6



PLR 780 NOIR

7











PLR 1000 NOIR

8



EURO 2000 NOIR

| n° |  |  |  |  |  |  |  |  |
|----|---|---|---|---|---|---|---|---|
| 9 | COUV PLR 500 | 169 x 130 | 23 | - | - | - | cristal | 12 x 50 |
| 10 | COUV PLR 780 | 183 x 141 | 24 | - | - | - | cristal | 12 x 50 |
| 11 | COUV PLR 1000 | 225 x 115 | 24 | - | - | - | cristal | 15 x 50 |
| 12 | COUV PLR 1500 | 244 x 172 | 24 | - | - | - | cristal | 6 x 50 |
| 13 | COUV PGR 1500 | 270 x 168 | 24 | - | - | - | cristal | 6 x 50 |
| 14 | COUV EURO 2000 | 298 x 198 | 24 | - | - | - | cristal | 3 x 50 |



9



COUV PLR 500

10



COUV PLR 780

11



COUV PLR 1000

12



COUV PLR 1500

13



COUV PGR 1500

14



COUV EURO 2000



Gamme plastique

| | | | |
|--|------------|---|------------|
| | | | |
| Fresh box, boîte salade charnière (APET) | 90 | Plat à compartiments noir (PP) | 104 |
| Salade box, boîte salade à charnière déchirable (APET) | 91 | Plat à compartiments blanc (PP) | 105 |
| Barquette charcutière translucide (PS) | 92 | Éco box, boîte translucide à couvercle séparé (PP) | 106 |
| Presti box, boîte salade design à couvercle séparé (APET) | 94 | Éco box, boîte noire à couvercle séparé (PP), coque poulet | 109 |
| Saladier et couvercle cristal | 96 | Menu box, plat menu noir (PP) | 110 |
| Thermo box, barquette translucide thermoscellable (PP) pour préparation chaude | 98 | Menu box, couvercle plat menu noir (OPS) | 111 |
| Thermo box, barquette noire thermoscellable (PP) pour préparation chaude | 99 | INJ box, pot rond (PP) | 113 |
| Gastro box, barquette gastronomique thermoscellable (PP) pour préparation froide | 100 | Cristal box | 114 |
| Gastro box, barquette gastronomique injectée (PP) pour préparation chaude | 101 | Carty box, barquette injectée | 115 |
| Micro box, boîte charnière micro-ondable (PP) | 102 | Pot à sauce PP charnière | 116 |
| | | Pot à coulis (APET) | 117 |
| | | Pot à coulis (PP) | 118 |
| | | Pot crème (PP), moule traiteur | 119 |
| | | Pot à vis | 120 |
| | | Plateau repas | 122 |
| | | Coquille plastique et boîte pour coquille, part de tarte et triangle sandwich | 125 |
| | | Assiette (OPS et PP) | 126 |
| | | Bol (PP) | 127 |
| | | Pot fast | 128 |
| | | Couvert Rlux réutilisable | 129 |
| | | Plateau | 130 |
| | | Verrine | 131 |
| | | Verrine injectée cristal | 132 |
| | | Verre injectés cristal | 135 |
| | | Flûte, verre réutilisable | 136 |
| | | Flûte, verre à eau, verre à vin réutilisable (PS injecté) | 138 |
| | | Assiette carrée injectée 180 x 180 | 150 |
| | | Assiette carrée injectée 240 x 240 | 154 |
| | | Sous-assiette carrée 300 x 300 | 157 |
| | | Assiette ronde injectée Ø 190 | 160 |
| | | Assiette ronde injectée Ø 240 | 164 |
| | | Sous-assiette ronde injectée Ø 300 | 168 |
| | | Coupe dessert (PS, PP) | 171 |
| | | Pot dessert (APET) | 173 |

Ergo box
boîte salade charnière (APET)



| n° | | | | | | |
|----|---------|--------------|-------|---------|---------|---------|
| 1 | ES 150 | 128 × 117 mm | 25 mm | 150 ml | Cristal | 12 × 50 |
| 2 | ES 250 | 128 × 117 mm | 45 mm | 250 ml | Cristal | 12 × 50 |
| 3 | ES 375 | 128 × 117 mm | 55 mm | 375 ml | Cristal | 12 × 50 |
| 4 | ES 500 | 148 × 125 mm | 50 mm | 500 ml | Cristal | 12 × 50 |
| 5 | ES 751 | 148 × 125 mm | 85 mm | 751 ml | Cristal | 12 × 50 |
| 6 | ES 600 | 190 × 148 mm | 45 mm | 600 ml | Cristal | 8 × 50 |
| 7 | ES 750 | 190 × 148 mm | 55 mm | 750 ml | Cristal | 8 × 50 |
| 8 | ES 1000 | 190 × 148 mm | 70 mm | 1000 ml | Cristal | 8 × 50 |
| 9 | ES 1500 | 190 × 185 mm | 60 mm | 1500 ml | Cristal | 4 × 50 |
| 10 | ES 2000 | 190 × 185 mm | 80 mm | 2000 ml | Cristal | 4 × 50 |

Tenue en température : -40° / +70°

1



ES 150

2



ES 250

3



ES 375

4



ES 500

5



ES 751

6



ES 600

7



ES 750

8



ES 1000

9



ES 1500

10



ES 2000



Fresh box
boîte salade charnière (APET)

Tenue en température : -40° / +70°



| n° | | | | | | | |
|----|---------|--------------|-------|---------|---------|---------|--|
| 1 | AB 250 | 130 × 106 mm | 52 mm | 250 ml | Cristal | 12 × 50 | |
| 2 | AB 375 | 147 × 131 mm | 45 mm | 375 ml | Cristal | 6 × 50 | |
| 3 | AB 500 | 147 × 131 mm | 60 mm | 500 ml | Cristal | 6 × 50 | |
| 4 | AB 600 | 195 × 150 mm | 50 mm | 600 ml | Cristal | 8 × 50 | |
| 5 | AB 750 | 195 × 150 mm | 57 mm | 750 ml | Cristal | 8 × 50 | |
| 6 | AB 1000 | 195 × 150 mm | 74 mm | 1000 ml | Cristal | 8 × 50 | |
| 7 | AB 1500 | 232 × 181 mm | 70 mm | 1500 ml | Cristal | 4 × 50 | |
| 8 | AB 2000 | 232 × 181 mm | 83 mm | 2000 ml | Cristal | 4 × 50 | |

NEW!

1



AB 250

NEW!

2



AB 375

NEW!

3



AB 500

NEW!

4



AB 600

NEW!

5



AB 750

NEW!

6



AB 1000

NEW!

7



AB 1500







NEW!

8



AB 2000

Salade box, boîte salade à charnière déchirable (APET)

| n° |  |  |  |  |  |  |
|----|---|---|---|--|---|---|
| 1 | GFT 250 | Ø 120 mm | 70 mm | 250 ml | Cristal | 14 × 50 |
| 2 | GFT 375 | Ø 135 mm | 80 mm | 370 ml | Cristal | 8 × 50 |
| 3 | GFT 500 | Ø 155 mm | 80 mm | 500 ml | Cristal | 6 × 50 |
| 4 | GFT 600 | Ø 173 mm | 75 mm | 600 ml | Cristal | 6 × 50 |
| 5 | GFT 750 | Ø 173 mm | 90 mm | 750 ml | Cristal | 6 × 50 |
| 6 | GFT 1000 | Ø 187 mm | 103 mm | 1000 ml | Cristal | 4 × 50 |



1



GFT 250

2



GFT 375

3



GFT 500

4



GFT 600

5



GFT 750

6



GFT 1000

Barquette charcutière translucide (PS)



| n° | | | | | | |
|----|--------|--------------|-------|--------|-------------|----------|
| 1 | BC 40 | 60 × 60 mm | 22 mm | 40 ml | Translucide | 9 × 250 |
| 2 | BC 75 | 75 × 65 mm | 30 mm | 75 ml | Translucide | 12 × 500 |
| 3 | BC 100 | 92 × 62 mm | 32 mm | 100 ml | Translucide | 12 × 500 |
| 4 | BC 125 | 91 × 71 mm | 35 mm | 125 ml | Translucide | 10 × 500 |
| 5 | BC 150 | 113 × 67 mm | 34 mm | 150 ml | Translucide | 12 × 500 |
| 6 | BC 200 | 112 × 88 mm | 33 mm | 200 ml | Translucide | 6 × 500 |
| 7 | BC 250 | 111 × 87 mm | 42 mm | 250 ml | Translucide | 6 × 500 |
| 8 | BC 375 | 138 × 90 mm | 46 mm | 375 ml | Translucide | 10 × 250 |
| 9 | BC 500 | 143 × 111 mm | 49 mm | 500 ml | Translucide | 6 × 500 |

1



BC 40

2



BC 75

3



BC 100

4



BC 125

5



BC 150

6



BC 200

7



BC 250

8









BC 375

9



BC 500

Barquette charcutière
translucide (PS)

| n° |  |  |  |  |  |  |  |
|----|---|---|---|--|---|---|---|
| 10 | BC 750 | 175 × 117 mm | 60 mm | 750 ml | Translucide | 6 × 250 | |
| 11 | BC 1000 | 189 × 144 mm | 54 mm | 1000 ml | Translucide | 4 × 250 | |
| 12 | BC 1500 | 202 × 152 mm | 62 mm | 1400 ml | Translucide | 4 × 250 | |
| 13 | BC 2000 | 215 × 196 mm | 67 mm | 2000 ml | Translucide | 3 × 250 | |
| 14 | BC 3000 | 248 × 213 mm | 88 mm | 3000 ml | Translucide | 2 × 100 | |
| - | BA 1 PIED | 222 × 80 mm | 30 mm | - | Translucide | 8 × 250 | |
| - | BA 2 PIEDS | 266 × 98 mm | 38 mm | - | Translucide | 4 × 250 | |



10

BC 750



11

BC 1000



12

BC 1500



13

BC 2000



14

BC 3000

Presti box, boîte salade design
à couvercle séparé (APET)



| n° | | | | | | | |
|----|----------------|----------------------------------|--------------|-------|---------|---------|--------|
| 1 | SCP 24 BLACK | Saladier presti box 750 ml | 196 × 196 mm | 46 mm | 750 ml | Noir | 8 × 50 |
| 2 | SCP 24 CRISTAL | Saladier presti box 750 ml | 196 × 196 mm | 46 mm | 750 ml | Cristal | 8 × 50 |
| 3 | SCP 32 BLACK | Saladier presti box 1000 ml | 196 × 196 mm | 60 mm | 1000 ml | Noir | 8 × 50 |
| 4 | SCP 32 CRISTAL | Saladier presti box 1000 ml | 196 × 196 mm | 60 mm | 1000 ml | Cristal | 8 × 50 |
| 5 | COUV SCP 24/32 | Couvercle presti box 750/1000 ml | 196 × 196 mm | 19 mm | - | Cristal | 8 × 50 |



1

SCP 24 BLACK



2

SCP 24 CRISTAL



3

SCP 32 BLACK



4

SCP 32 CRISTAL



5

COUV SCP 24/32



Saladier et couvercle cristal



| n° | | | | | | | |
|----|------------------|----------------------------|----------|-------|---------|---------|---------|
| 1 | SA 500 | Saladier 500 ml APET | Ø 140 mm | 63 mm | 500 ml | Cristal | 12 × 40 |
| 2 | SA 750 | Saladier 750 ml APET | Ø 187 mm | 58 mm | 750 ml | Cristal | 8 × 50 |
| 3 | SA 750 NOIR | Saladier 750 ml APET noir | Ø 187 mm | 58 mm | 750 ml | Noir | 8 × 50 |
| 4 | SA 1000 | Saladier 1000 ml APET | Ø 187 mm | 75 mm | 1000 ml | Cristal | 8 × 50 |
| 5 | SA 1000 NOIR | Saladier 1000 ml APET noir | Ø 187 mm | 75 mm | 1000 ml | Noir | 8 × 50 |
| 6 | COUV SA 500 | Couvercle dôme PET | Ø 140 mm | 20 mm | – | Cristal | 12 × 40 |
| 7 | COUV SA 750/1000 | Couvercle dôme PET | Ø 187 mm | 22 mm | – | Cristal | 8 × 50 |

NEW!

1



SA 500

2



SA 750

3



SA 750 NOIR

4



SA 1000

5



SA 1000 NOIR

NEW!

6



COUV SA 500

7



COUV SA 750/1000

Saladier et couvercle cristal



| n° |  |  |  |  |  |  |  |  |
|----|---|---|---|--|---|---|---|---|
| 8 | SA 1500 | Saladier 1500 ml APET | Ø 232 mm | 79 mm | 1500 ml | Cristal | 6 × 50 | |
| 9 | COUV SA 1500 | Couvercle dôme PET | Ø 232 mm | 30 mm | - | Cristal | 8 × 50 | |
| 10 | SA 2250 | Saladier 2250 ml APET | Ø 260 mm | 92 mm | 2250 ml | Cristal | 2 × 25 | |
| 11 | COUV SA 2250 | Couvercle dôme PET | Ø 260 mm | 38 mm | - | Cristal | 2 × 25 | |
| 12 | SA 4500 | Saladier 4500 ml APET | Ø 305 mm | 116 mm | 4500 ml | Cristal | 2 × 25 | |
| 13 | COUV SA 4500 | Couvercle dôme PET | Ø 305 mm | 38 mm | - | Cristal | 2 × 25 | |



8

SA 1500



10

SA 2250



12

SA 4500



9

COUV SA 1500



11

COUV SA 2250



13

COUV SA 4500

Thermo box
barquette translucide
thermoscellable (PP)
pour préparation chaude



| n° | | | | | | | |
|----|----------------------------|--------------------------------|-----------------------|--------|------------|-------------|----------|
| 1 | SEL 170 | Barquette thermoscellable 170 | 137 × 96 mm | 26 mm | 180 ml | Translucide | 12 × 100 |
| 2 | SEL 250 | Barquette thermoscellable 250 | 137 × 96 mm | 30 mm | 250 ml | Translucide | 12 × 100 |
| 3 | SEL 300 | Barquette thermoscellable 300 | 137 × 96 mm | 42 mm | 300 ml | Translucide | 12 × 100 |
| 4 | SEL 375 | Barquette thermoscellable 375 | 137 × 96 mm | 46 mm | 375 ml | Translucide | 12 × 100 |
| 5 | SEL 500 | Barquette thermoscellable 500 | 137 × 96 mm | 65 mm | 500 ml | Translucide | 12 × 100 |
| 6 | SEL 650 | Barquette thermoscellable 650 | 137 × 96 mm | 41 mm | 650 ml | Translucide | 6 × 100 |
| 7 | SEL 750 | Barquette thermoscellable 750 | 192 × 138 mm | 47 mm | 750 ml | Translucide | 6 × 100 |
| 8 | SEL 1000 | Barquette thermoscellable 1000 | 192 × 138 mm | 62 mm | 1000 ml | Translucide | 6 × 100 |
| 9 | SEL 1200 | Barquette thermoscellable 1200 | 192 × 138 mm | 76 mm | 1200 ml | Translucide | 6 × 100 |
| 10 | SEL 1500 | Barquette thermoscellable 1500 | 192 × 138 mm | 90 mm | 1500 ml | Translucide | 6 × 100 |
| 11 | SEL 2000 | Barquette thermoscellable 2000 | 192 × 138 mm | 100 mm | 1800 ml | Translucide | 6 × 100 |
| 12 | FILM 150 × 500 PP SOUDABLE | - | Laize 150 × 500 mm | - | 0,15 × 500 | Transparent | 1 |

Tenue en température : -20° / +110°



1

SEL 170



2

SEL 250



3

SEL 300



4

SEL 375



5

SEL 500



6

SEL 650



7

SEL 750



8

SEL 1000



9

SEL 1200



10

SEL 1500









11

SEL 2000



12

FILM 150 × 500 PP SOUDABLE

| n° |  |  |  |  |  |  |  |
|----|--|--|--|---|--|--|--|
| 1 | SEL N 250 | Barquette thermoscellable noire 250 | 137 × 96 mm | 30 mm | 250 ml | Noir | 18 × 100 |
| 2 | SEL N 375 | Barquette thermoscellable noire 375 | 137 × 96 mm | 46 mm | 375 ml | Noir | 14 × 100 |
| 3 | SEL N 500 | Barquette thermoscellable noire 500 | 137 × 96 mm | 65 mm | 500 ml | Noir | 12 × 100 |
| 4 | SEL N 750 | Barquette thermoscellable noire 750 | 192 × 138 mm | 47 mm | 750 ml | Noir | 6 × 100 |
| 5 | SEL N 1000 | Barquette thermoscellable noire 1000 | 192 × 138 mm | 62 mm | 1000 ml | Noir | 6 × 100 |
| 6 | SEL N 1200 | Barquette thermoscellable noire 1200 | 192 × 138 mm | 76 mm | 1200 ml | Noir | 6 × 100 |
| 7 | SEL N 1500 | Barquette thermoscellable noire 1500 | 192 × 138 mm | 90 mm | 1500 ml | Noir | 6 × 100 |



Thermo box
barquette noire thermoscellable
(PP) pour préparation chaude

Tenue en température : -20° / +110°



1

SEL N 250



2

SEL N 375



3

SEL N 500



4

SEL N 750



5

SEL N 1000



6

SEL N 1200



7

SEL N 1500

Gastro box
barquette gastronomique
thermoscellable (PP)
pour préparation froide









n°



| n° | | | | | | | |
|----|------------|----------------------------------|--------------|-------|---------|-------|---------|
| 1 | GN4 H40 BF | Barquette gastronomique 4 H40 PP | 263 × 162 mm | 40 mm | 900 ml | Blanc | 6 × 115 |
| 1 | GN4 H45 BF | Barquette gastronomique 4 H45 PP | 263 × 162 mm | 45 mm | 1250 ml | Blanc | 6 × 115 |
| 1 | GN4 H55 BF | Barquette gastronomique 4 H55 PP | 263 × 162 mm | 55 mm | 1500 ml | Blanc | 6 × 110 |
| 1 | GN4 H75 BF | Barquette gastronomique 4 H75 PP | 263 × 162 mm | 75 mm | 2000 ml | Blanc | 6 × 115 |
| 2 | GN2 H48 BF | Barquette gastronomique 2 H48 PP | 325 × 265 mm | 48 mm | 3000 ml | Blanc | 3 × 76 |
| 2 | GN2 H52 BF | Barquette gastronomique 2 H52 PP | 325 × 265 mm | 52 mm | 3200 ml | Blanc | 3 × 72 |
| 2 | GN2 H60 BF | Barquette gastronomique 2 H60 PP | 325 × 265 mm | 60 mm | 3700 ml | Blanc | 3 × 70 |
| 2 | GN2 H70 BF | Barquette gastronomique 2 H70 PP | 325 × 265 mm | 70 mm | 4200 ml | Blanc | 3 × 70 |
| 2 | GN2 H80 BF | Barquette gastronomique 2 H80 PP | 325 × 265 mm | 80 mm | 4700 ml | Blanc | 3 × 68 |
| 2 | GN2 H95 BF | Barquette gastronomique 2 H95 PP | 325 × 265 mm | 95 mm | 5000 ml | Blanc | 3 × 65 |

Tenue en température : -20° / +110°



| n° |  |  |  |  |  |  |  |
|----|--|--|--|---|--|--|--|
| 1 | GN 1/8 H36 | Barquette gastronomique 1/8 H36 | 158 × 128 mm | 36 mm | 450 ml | Blanc | 720 |
| 2 | GN 1/8 H45 | Barquette gastronomique 1/8 H45 | 158 × 128 mm | 45 mm | 550 ml | Blanc | 760 |
| 3 | GN 1/6 H48 | Barquette gastronomique 1/6 H48 | 176 × 158 mm | 48 mm | 900 ml | Blanc | 528 |
| 4 | GN 1/4 H45 | Barquette gastronomique 1/4 H45 | 263 × 158 mm | 45 mm | 1250 ml | Blanc | 360 |
| 5 | GN 1/4 H55 | Barquette gastronomique 1/4 H55 | 263 × 158 mm | 55 mm | 1450 ml | Blanc | 360 |
| 6 | GN 1/3 H48 | Barquette gastronomique 1/3 H48 | 325 × 175 mm | 48 mm | 1778 ml | Blanc | 270 |
| 7 | GN 1/2 H48 | Barquette gastronomique 1/2 H48 | 325 × 265 mm | 48 mm | 2775 ml | Blanc | 140 |
| 8 | GN 1/2 H52 | Barquette gastronomique 1/2 H52 | 325 × 265 mm | 52 mm | 3250 ml | Blanc | 132 |
| 9 | GN 1/2 H80 | Barquette gastronomique 1/2 H80 | 325 × 265 mm | 80 mm | 5000 ml | Blanc | 66 |
| 10 | FILM DE SCELLAGE PELABLE OU SOUDABLE | | | - | - | - | 1 |



Gastro box
barquette gastronomique
injectée (PP)
pour préparation chaude

Tenue en température : -20° / +130°

1



GN 1/8 H36

2



GN 1/8 H45

3



GN 1/6 H48

4



GN 1/4 H45

5



GN 1/4 H55

6



GN 1/3 H48

7



GN 1/2 H48

8



GN 1/2 H52

9



GN 1/2 H80

10



FILM DE SCELLAGE PELABLE OU SOUDABLE

Micro box boîte charnière micro-ondable (PP)



Tenue en température : -20° / +110°

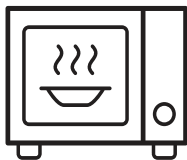

| n° | | | | | | | |
|----|----------|--------------------------------------|--------------|-------|---------|-------------|---------|
| 1 | BMF 250 | Barquette multi-fonctions 250 ml PP | 128 × 117 mm | 45 mm | 250 ml | Translucide | 12 × 50 |
| 2 | BMF 375 | Barquette multi-fonctions 375 ml PP | 128 × 117 mm | 55 mm | 375 ml | Translucide | 12 × 50 |
| 3 | BMF 500 | Barquette multi-fonctions 500 ml PP | 148 × 125 mm | 50 mm | 500 ml | Translucide | 12 × 50 |
| 4 | BMF 750 | Barquette multi-fonctions 750 ml PP | 190 × 148 mm | 55 mm | 750 ml | Translucide | 8 × 50 |
| 5 | BMF 1000 | Barquette multi-fonctions 1000 ml PP | 190 × 148 mm | 70 mm | 1000 ml | Translucide | 8 × 50 |
| 6 | BMF 1500 | Barquette multi-fonctions 1500 ml PP | 190 × 185 mm | 60 mm | 1500 ml | Translucide | 4 × 50 |
| 7 | BMF 2000 | Barquette multi-fonctions 2000 ml PP | 190 × 185 mm | 80 mm | 2000 ml | Translucide | 4 × 50 |



1

BMF 250



2

BMF 375



3

BMF 500



4

BMF 750



5

BMF 1000



6

BMF 1500



7

BMF 2000



Plat à compartiments noir (PP)



Tenue en température : -20° / +120°

| n° | | | | | | | | | | |
|----|--------------|-----------------------------|--------------|-------|--------------|--------------|-----------------|---------|-----|--|
| 1 | PC 1 PPN H32 | Plat 1 compartiment PP H32 | 227 × 178 mm | 32 mm | 210 × 160 mm | 190 × 140 mm | 905 ml | Noir | 360 | |
| 2 | PC 1 PPN H40 | Plat 1 compartiment PP H40 | 227 × 178 mm | 40 mm | 210 × 160 mm | 190 × 140 mm | 1050 ml | Noir | 360 | |
| 3 | PC 1 PPN H50 | Plat 1 compartiment PP H50 | 227 × 178 mm | 50 mm | 210 × 160 mm | 183 × 135 mm | 1400 ml | Noir | 360 | |
| 4 | PC 2 PPN H32 | Plat 2 compartiments PP H32 | 227 × 178 mm | 32 mm | 210 × 160 mm | 190 × 140 mm | 440 + 380 ml | Noir | 360 | |
| 5 | PC 2 PPN H40 | Plat 2 compartiments PP H40 | 227 × 178 mm | 40 mm | 210 × 160 mm | 190 × 140 mm | 542 + 467 ml | Noir | 360 | |
| 6 | PC 2 PPN H50 | Plat 2 compartiments PP H50 | 227 × 178 mm | 50 mm | 210 × 160 mm | 183 × 135 mm | 648 + 555 ml | Noir | 360 | |
| 7 | PC 3 PPN H32 | Plat 3 compartiments PP H32 | 227 × 178 mm | 32 mm | 210 × 160 mm | 190 × 140 mm | 365 + 230 + 170 | Noir | 360 | |
| 8 | PC 3 PPN H40 | Plat 3 compartiments PP H40 | 227 × 178 mm | 40 mm | 210 × 160 mm | 190 × 140 mm | 585 + 405 + 125 | Noir | 360 | |
| 9 | PC 3 PPN H50 | Plat 3 compartiments PP H50 | 227 × 178 mm | 50 mm | 210 × 160 mm | 183 × 135 mm | 648 + 555 + 275 | Noir | 360 | |
| 10 | DOME PC | Dôme plat à compartiment | 227 × 178 mm | 10 mm | - | - | - | Cristal | 500 | |



1

PC 1 PPN H32



2

PC 1 PPN H40



3

PC 1 PPN H50



4

PC 2 PPN H32



5

PC 2 PPN H40



6

PC 2 PPN H50



7

PC 3 PPN H32



8

PC 3 PPN H40



9

PC 3 PPN H50



10

DOME PC



FILM - NOUS CONSULTER



Plat à compartiments blanc (PP)

| | | | | | | | | | |
|----|--------------|-----------------------------|--------------|-------|--------------|--------------|-----------------|---------|-----|
| 1 | PC 1 PPB H32 | Plat 1 compartiment PP H32 | 227 × 178 mm | 32 mm | 210 × 160 mm | 190 × 140 mm | 905 ml | Blanc | 360 |
| 2 | PC 1 PPB H40 | Plat 1 compartiment PP H40 | 227 × 178 mm | 40 mm | 210 × 160 mm | 190 × 140 mm | 1050 ml | Blanc | 360 |
| 3 | PC 1 PPB H50 | Plat 1 compartiment PP H50 | 227 × 178 mm | 50 mm | 210 × 160 mm | 183 × 135 mm | 1400 ml | Blanc | 360 |
| 4 | PC 2 PPB H32 | Plat 2 compartiments PP H32 | 227 × 178 mm | 32 mm | 210 × 160 mm | 190 × 140 mm | 440 + 380 ml | Blanc | 360 |
| 5 | PC 2 PPB H40 | Plat 2 compartiments PP H40 | 227 × 178 mm | 40 mm | 210 × 160 mm | 190 × 140 mm | 542 + 467 ml | Blanc | 360 |
| 6 | PC 2 PPB H50 | Plat 2 compartiments PP H50 | 227 × 178 mm | 50 mm | 210 × 160 mm | 183 × 135 mm | 648 + 555 ml | Blanc | 360 |
| 7 | PC 3 PPB H32 | Plat 3 compartiments PP H32 | 227 × 178 mm | 32 mm | 210 × 160 mm | 190 × 140 mm | 365 + 230 + 170 | Blanc | 360 |
| 8 | PC 3 PPB H40 | Plat 3 compartiments PP H40 | 227 × 178 mm | 40 mm | 210 × 160 mm | 190 × 140 mm | 585 + 405 + 125 | Blanc | 360 |
| 9 | PC 3 PPB H50 | Plat 3 compartiments PP H50 | 227 × 178 mm | 50 mm | 210 × 160 mm | 183 × 135 mm | 648 + 555 + 275 | Blanc | 360 |
| 10 | DOME PC | Dôme plat à compartiment | 227 × 178 mm | 10 mm | - | - | - | Cristal | 500 |

Tenue en température : -20° / +120°



1

PC 1 PPB H32



2

PC 1 PPB H40



3

PC 1 PPB H50



4

PC 2 PPB H32



5

PC 2 PPB H40



6

PC 2 PPB H50



7

PC 3 PPB H32



8

PC 3 PPB H40



9

PC 3 PPB H50



10

DOME PC



FILM - NOUS CONSULTER

Éco box
boîte translucide
à couvercle séparé (PP)



| n° | | | | | | | |
|----|-------------------------|---------------------------------|--------------|-------|--------|-------------|---------|
| 1 | ECO 125 PP | Boîte translucide 125 ml | 108 × 82 mm | 31 mm | 125 ml | Translucide | 20 × 50 |
| 2 | ECO 150 PP | Boîte translucide 150 ml | 108 × 82 mm | 36 mm | 150 ml | Translucide | 20 × 50 |
| 3 | ECO 200 PP | Boîte translucide 200 ml | 108 × 82 mm | 45 mm | 200 ml | Translucide | 20 × 50 |
| 4 | ECO 250 PP | Boîte translucide 250 ml | 108 × 82 mm | 54 mm | 250 ml | Translucide | 20 × 50 |
| 5 | ECO 300 PP | Boîte translucide 300 ml | 108 × 82 mm | 58 mm | 300 ml | Translucide | 20 × 50 |
| 6 | ECO 500 HAUTE PP | Boîte translucide 500 ml haute | 108 × 82 mm | 97 mm | 500 ml | Translucide | 20 × 50 |
| 7 | COUVERCLE ECO PM | Couvercle boîte éco PM | 112 × 86 mm | 5 mm | - | Translucide | 20 × 50 |
| 8 | ECO 500 CARRE PP | Boîte translucide 500 ml carrée | 115 × 115 mm | 63 mm | 500 ml | Translucide | 10 × 50 |
| 9 | COUVERCLE ECO 500 CARRE | Couvercle boîte éco 500 carré | 115 × 115 mm | 5 mm | - | Translucide | 10 × 50 |



1

ECO 125 PP



2

ECO 150 PP



3

ECO 200 PP



4

ECO 250 PP



5

ECO 300 PP



6

ECO 500 HAUTE PP



7

COUVERCLE ECO PM



8







ECO 500 CARRE PP



9

COUVERCLE ECO 500 CARRE

Tenue en température : -20° / +110°

| n° |  |  |  |  |  |  |  |
|----|--|--|--|--|--|--|--|
| 10 | ECO 500 PLATE PP | Boîte translucide 500 ml plate | 180 × 133 mm | 33 mm | 500 ml | Translucide | 6 × 50 |
| 11 | ECO 750 PP | Boîte translucide 750 ml | 180 × 133 mm | 46 mm | 750 ml | Translucide | 6 × 50 |
| 12 | ECO 1000 PP | Boîte translucide 1000 ml | 180 × 133 mm | 62 mm | 1000 ml | Translucide | 6 × 50 |
| 13 | ECO 1500 PP | Boîte translucide 1500 ml | 180 × 133 mm | 88 mm | 1500 ml | Translucide | 6 × 50 |
| 14 | ECO 2000 PP | Boîte translucide 2000 ml | 180 × 133 mm | 123 mm | 2000 ml | Translucide | 6 × 50 |
| 15 | COUV ECO GM | Couvercle boîte éco GM | 186 × 140 mm | 5 mm | – | Translucide | 6 × 50 |



Éco box
boîte translucide
à couvercle séparé (PP)

Tenue en température : -20° / +110°



10

ECO 500 PLATE PP



11

ECO 750 PP



12

ECO 1000 PP



13

ECO 1500 PP



14







ECO 2000 PP



15

COUV ECO GM



| n° |  |  |  |  |  |  |  |
|----|--|--|--|--|--|--|--|
| 1 | ECO 500 NOIRE PP | Boîte noire 500 ml | 180 × 133 mm | 32 mm | 500 ml | Noir | 6 × 50 |
| 2 | ECO 750 NOIRE PP | Boîte noire 750 ml | 180 × 133 mm | 46 mm | 750 ml | Noir | 6 × 50 |
| 3 | ECO 1000 NOIRE PP | Boîte noire 1000 ml | 180 × 133 mm | 62 mm | 1000 ml | Noir | 6 × 50 |
| 4 | ECO 1500 NOIRE PP | Boîte noire 1500 ml | 180 × 133 mm | 94 mm | 1500 ml | Noir | 6 × 50 |
| 5 | COUV ECO GM | Couvercle boîte éco GM | 186 × 140 mm | 5 mm | – | Translucide | 6 × 50 |



Éco box
boîte noire à couvercle séparé
(PP)

Tenue en température : -20° / +110°

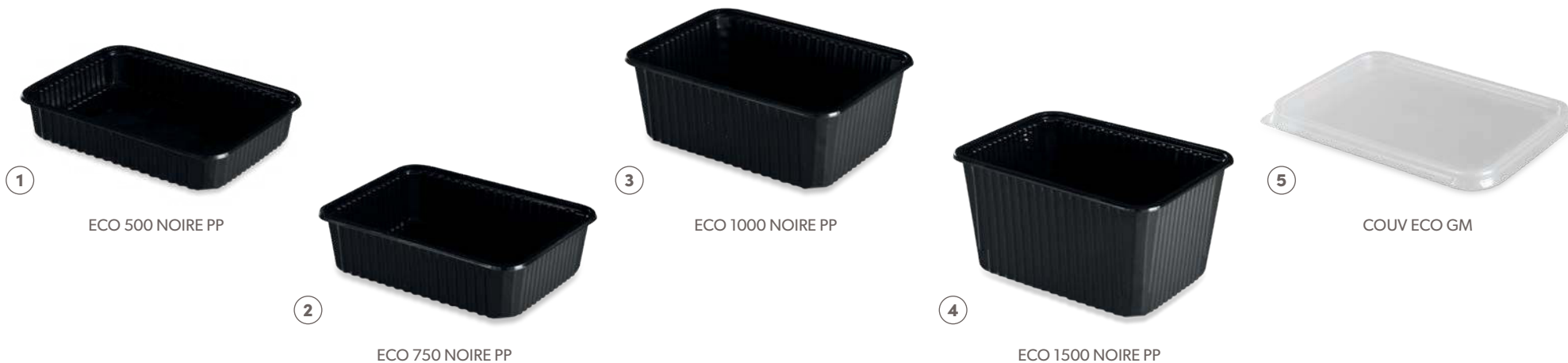

| n° |  |  |  |  |  |  |
|----|---|---|---|---|---|---|
| 1 | 6007 | Coque poulet 6007 + couvercle | 264 × 200 mm | 112 mm | Translucide/noir | 100 |
| 2 | 6003 | Coque poulet 6003 + couvercle | 273 × 216 mm | 118 mm | Translucide/noir | 100 |



Coque poulet (PP)

Tenue en température : -20° / +110°

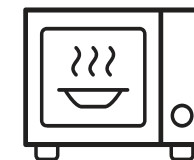

Menu box plat menu noir (PP)



Tenue en température : -20° / +120°

| n° | | | | | | | |
|----|-----------|---------------------------|--------------|-------|--------------------|------|-----|
| 1 | CN 8 4608 | Plat 1 comp noir PP 8 oz | 156 × 124 mm | 32 mm | 240 ml | Noir | 232 |
| 2 | CN 8 4612 | Plat 1 comp noir PP 12 oz | 156 × 124 mm | 41 mm | 360 ml | Noir | 232 |
| 3 | CN 8 4616 | Plat 1 comp noir PP 16 oz | 206 × 170 mm | 25 mm | 480 ml | Noir | 252 |
| 4 | CN 8 4624 | Plat 1 comp noir PP 24 oz | 206 × 170 mm | 37 mm | 720 ml | Noir | 252 |
| 5 | CN 8 4632 | Plat 1 comp noir PP 32 oz | 206 × 170 mm | 49 mm | 960 ml | Noir | 252 |
| 6 | CN 8 4636 | Plat 1 comp noir PP 36 oz | 239 × 205 mm | 42 mm | 1080 ml | Noir | 252 |
| 7 | CN 8 4637 | Plat 2 comp noir PP 37 oz | 239 × 205 mm | 38 mm | 630 + 300 ml | Noir | 252 |
| 8 | CN 8 4638 | Plat 3 comp noir PP 38 oz | 239 × 205 mm | 38 mm | 630 + 135 + 135 ml | Noir | 252 |



1

CN 8 4608



2

CN 8 4612



3

CN 8 4616



4

CN 8 4624



5

CN 8 4632



6

CN 8 4636



7

CN 8 4637









8

CN 8 4638







Menu box
couverture plat menu noir (OPS)



| n° |  |  |  |  |  |  |  |
|----|---|---|---|---|---|---|---|
| 9 | CN 8 460 H | Couvercle pour CN 8 4608 et 4612 | 156 × 124 mm | 25,4 mm | Cristal | 232 | |
| 10 | CN 8 462 H | Couvercle pour CN 8 4616 à 4632 | 206 × 170 mm | 27 mm | Cristal | 252 | |
| 11 | CN 8 466 H | Couvercle pour CN 8 4636 | 239 × 205 mm | 34 mm | Cristal | 252 | |
| 12 | CN 8 467 H | Couvercle pour CN 8 4637 | 239 × 205 mm | 30 mm | Cristal | 252 | |
| 13 | CN 8 468 H | Couvercle pour CN 8 4638 | 239 × 205 mm | 32 mm | Cristal | 252 | |











| n° |  |  |  |  |  |  |  |
|----|--|--|--|---|--|--|--|
| 1 | INJ 500 | Barquette injectée 530 ml | 174 × 118 mm | 40 mm | 530 ml | Translucide | 10 × 50 |
| 2 | INJ 650 | Barquette injectée 650 ml | 174 × 118 mm | 50 mm | 630 ml | Translucide | 10 × 50 |
| 3 | INJ 750 | Barquette injectée 750 ml | 174 × 118 mm | 55 mm | 750 ml | Translucide | 10 × 50 |
| 4 | INJ 1000 | Barquette injectée 1000 ml | 174 × 118 mm | 70 mm | 1000 ml | Translucide | 10 × 50 |
| 5 | COUV INJ | Couvercle pour barquette injectée | 176 × 120 mm | 7 mm | - | Translucide | 10 × 50 |



INJ box

Tenue en température : -20° / +110°



| n° |  |  |  |  |  |  |  |
|----|---|---|---|--|---|---|---|
| 1 | PTRPP 125 | Pot rond 125 ml PP | Ø101 mm | 30 mm | 125 ml | Translucide | 10 × 100 |
| 2 | PTRPP 200 | Pot rond 200 ml PP | Ø101 mm | 41 mm | 200 ml | Translucide | 10 × 100 |
| 3 | PTRPP 250 | Pot rond 250 ml PP | Ø101 mm | 48 mm | 250 ml | Translucide | 10 × 100 |
| 4 | COUV PTRPP | Couvercle pour pot rond PP | Ø101 mm | - | - | Translucide | 10 × 100 |



Pot rond (PP)

Tenue en température : -20° / +110°



Cristal box



n°



| n° | | | | | | | | |
|----|----------|--|--------------|--------|---------|---------|---------|--|
| 1 | CBI 250 | Boîte cristal injectée 250 PP + couvercle | 138 × 104 mm | 38 mm | 290 ml | Cristal | 10 × 50 | |
| 2 | CBI 375 | Boîte cristal injectée 375 PP + couvercle | 138 × 104 mm | 53 mm | 430 ml | Cristal | 10 × 50 | |
| 3 | CBI 500 | Boîte cristal injectée 500 PP + couvercle | 138 × 104 mm | 68 mm | 570 ml | Cristal | 10 × 50 | |
| 4 | CBI 650 | Boîte cristal injectée 650 PP + couvercle | 159 × 120 mm | 47 mm | 650 ml | Cristal | 6 × 50 | |
| 5 | CBI 750 | Boîte cristal injectée 750 PP + couvercle | 183 × 139 mm | 53 mm | 840 ml | Cristal | 4 × 50 | |
| 6 | CBI 1000 | Boîte cristal injectée 1000 PP + couvercle | 183 × 139 mm | 67 mm | 1120 ml | Cristal | 4 × 50 | |
| 7 | CBI 1500 | Boîte cristal injectée 1500 PP + couvercle | 183 × 139 mm | 100 mm | 1730 ml | Cristal | 4 × 50 | |



Tenue en température :
-20° / +130°



1

CBI 250



2

CBI 375



3

CBI 500



4

CBI 650



5

CBI 750









6

CBI 1000



7

CBI 1500

| n° |  |  |  |  |  |  |  |
|----|--|--|--|--|--|--|--|
| 1 | R 45 | Boîte injectée rigide 450 ml | 121 × 106 mm | 54 mm | 450 ml | Translucide | 200 |
| 2 | R 75 | Boîte injectée rigide 750 ml | 142 × 118 mm | 68 mm | 750 ml | Translucide | 200 |
| 3 | R 110 | Boîte injectée rigide 1100 ml | 188 × 146 mm | 55 mm | 1100 ml | Translucide | 100 |
| 4 | R 115 | Boîte injectée rigide 1150 ml | 159 × 130 mm | 83 mm | 1150 ml | Translucide | 100 |
| 5 | R 135 | Boîte injectée rigide 1350 ml | 170 × 134 mm | 85 mm | 1350 ml | Translucide | 100 |
| 6 | R 180 | Boîte injectée rigide 1800 ml | 187 × 146 mm | 92 mm | 1800 ml | Translucide | 100 |



Carty box
Barquette injectée

Tenue en température :
-20° / +130°



1

R 45



2

R 75



3

R 110



4

R 115



5

R 135



6

R 180

Pot à sauce PP charnière



n°



| n° | | | | | | | |
|----|--------|--------------------------------|---------|---------|--------|-------------|---------|
| 1 | PAC 3 | Pot à sauce charnière PP 3 cl | Ø 50 mm | 26,6 mm | 30 ml | Translucide | 20 × 50 |
| 2 | PAC 6 | Pot à sauce charnière PP 6 cl | Ø 62 mm | 26,6 mm | 60 ml | Translucide | 20 × 50 |
| 3 | PAC 10 | Pot à sauce charnière PP 10 cl | Ø 71 mm | 35 mm | 100 ml | Translucide | 10 × 50 |
| 4 | PAC 12 | Pot à sauce charnière PP 12 cl | Ø 71 mm | 46,1 mm | 120 ml | Translucide | 10 × 50 |

Tenue en température : -20° / +110°

①



PAC 3

②



PAC 6

③



PAC 10

NEW!

④











PAC 12

NEW!

Pot à coulis (APET)



| n° |  |  |  |  |  |  |  |  |  |
|----|---|---|---|---|---|---|---|---|---|
| 1 | MD 8 | Pot à coulis 250 PET | Ø 117 mm | 45 mm | 237 ml | Cristal | 10 × 50 | | |
| 2 | MD 12 | Pot à coulis 360 PET | Ø 117 mm | 61 mm | 355 ml | Cristal | 10 × 50 | | |
| 3 | MD 16 | Pot à coulis 500 PET | Ø 117 mm | 75 mm | 473 ml | Cristal | 10 × 50 | | |
| 4 | MD 24 | Pot à coulis 750 PET | Ø 117 mm | 108 mm | 710 ml | Cristal | 10 × 50 | | |
| 5 | MD 32 | Pot à coulis 1000 PET | Ø 117 mm | 145 mm | 946 ml | Cristal | 10 × 50 | | |
| 6 | COUV MD | Couvercle pot à coulis PET | Ø 117 mm | 4 mm | - | Cristal | 10 × 50 | | |

Tenue en température : -40° / +70°



1

MD 8



2

MD 12



4

MD 24



5

MD 32



3

MD 16



6

COUV MD

Pot à coulis (PP)



Tenue en température : -20° / +110°

| n° | | | | | | | |
|----|--------------|----------------------------------|----------|--------|--------|-------------|---------|
| 1 | POC 250 PP | Pot à coulis 250 PP | Ø 110 mm | 45 mm | 237 ml | Translucide | 20 × 25 |
| 2 | POC 360 PP | Pot à coulis 360 PP | Ø 110 mm | 65 mm | 355 ml | Translucide | 20 × 25 |
| 3 | POC 500 PP | Pot à coulis 500 PP | Ø 110 mm | 85 mm | 473 ml | Translucide | 20 × 25 |
| 4 | POC 750 PP | Pot à coulis 750 PP | Ø 110 mm | 130 mm | 710 ml | Translucide | 20 × 25 |
| 5 | POC 1000 PP | Pot à coulis 1000 PP | Ø 110 mm | 150 mm | 946 ml | Translucide | 20 × 25 |
| 6 | CP 125 PP | Coupe dessert PP cristal | Ø 95 mm | 57 mm | 155 ml | Translucide | 24 × 25 |
| 7 | CP 125 PS | Coupe dessert PP cristal | Ø 95 mm | 57 mm | 155 ml | Cristal | 24 × 25 |
| 8 | COUV POC PP | Couvercle pot à coulis PP | Ø 110 mm | 7 mm | - | Translucide | 10 × 50 |
| 9 | COUV PLAT CP | Couvercle plat coupe dessert 125 | Ø 95 mm | 8 mm | - | Cristal | 12 × 50 |
| 10 | DOME CP | Dôme coupe dessert 125 | Ø 95 mm | 25 mm | - | Cristal | 12 × 50 |

1



POC 250 PP

2



POC 360 PP

3



POC 500 PP

4



POC 750 PP

5



POC 1000 PP

6



CP 125 PP

7



CP 125 PS

8



COUV POC PP

9









COUV PLAT CP

10



DOME CP

| n° |  |  |  |  |  |  |  |
|----|--|--|--|---|--|--|--|
| 1 | POC CREME 250 | Pot & couvercle blanc 250 ml | Ø 94,3 mm | 76,5 mm | 250 ml | Blanc | 10 × 50 |
| 2 | POC CREME 500 | Pot & couvercle blanc 500 ml | Ø 116 mm | 80,5 mm | 500 ml | Blanc | 11 × 40 |
| 3 | POC CREME 1000 | Pot & couvercle blanc 1000 ml | Ø 145 mm | 103 mm | 1000 ml | Blanc | 4 × 50 |

Pot crème (PP)



1

POC CREME 250









2

POC CREME 500



3

POC CREME 1000

| n° |  |  |  |  |  |  |  |
|----|---|---|---|--|---|---|---|
| 1 | MOEG | Moule à œuf en gelée | 81 × 60 mm | 35 mm | 90 ml | Translucide | 10 × 150 |
| 2 | MAMED | Moule médaillon | Ø 80 mm | 26 mm | 75 ml | Translucide | 16 × 250 |
| 3 | MAIG | Moule aiguillette | 149 × 49 mm | 32 mm | 125 ml | Translucide | 30 × 100 |
| 4 | MCJ | Moule cornet jambon | Ø 68 mm | 80 mm | 72 ml | Translucide | 24 × 250 |



Moule traiteur



1

MOEG



2

MAMED



3

MAIG



4

MCJ

Pot à vis



n°



| n° | | | | | | | |
|----|---------|---------------------------------|---------|--------|--------|---------|--------|
| 1 | POP 100 | Pot PET 100 ml + couvercle noir | Ø 69 mm | 39 mm | 100 ml | Cristal | 91 × 6 |
| 2 | POP 180 | Pot PET 180 ml + couvercle noir | Ø 69 mm | 61 mm | 180 ml | Cristal | 63 × 6 |
| 3 | POP 250 | Pot PET 250 ml + couvercle noir | Ø 69 mm | 79 mm | 250 ml | Cristal | 49 × 6 |
| 4 | POP 300 | Pot PET 300 ml + couvercle noir | Ø 69 mm | 91 mm | 300 ml | Cristal | 39 × 6 |
| 5 | POP 400 | Pot PET 400 ml + couvercle noir | Ø 69 mm | 117 mm | 400 ml | Cristal | 28 × 6 |
| 6 | POP 500 | Pot PET 500 ml + couvercle noir | Ø 69 mm | 144 mm | 500 ml | Cristal | 26 × 6 |
| 7 | POG 280 | Pot PET 280 ml + couvercle noir | Ø 89 mm | 62 mm | 280 ml | Cristal | 36 × 6 |
| 8 | POG 400 | Pot PET 400 ml + couvercle noir | Ø 89 mm | 81 mm | 400 ml | Cristal | 28 × 6 |
| 9 | POG 500 | Pot PET 500 ml + couvercle noir | Ø 89 mm | 93 mm | 500 ml | Cristal | 24 × 6 |

1



POP 100

NEW!

2



POP 180

NEW!

3



POP 250

NEW!

4



POP 300

NEW!

5



POP 400

NEW!

6



POP 500

NEW!

7



POG 280

NEW!

8



POG 400

NEW!

9



POG 500

NEW!



Plateau repas



n°



| n° | | | | | | |
|----|-----------------|--|--------------|-------|---------|--------|
| 1 | PR 5 C ECO | Plateau repas 5 compartiments blanc éco | 318 × 223 mm | 34 mm | Blanc | 4 × 50 |
| 2 | COUV PR 5 C ECO | Couvercle plateau repas 5 compartiments | 330 × 223 mm | 34 mm | Cristal | 4 × 25 |
| 3 | PR 5 C GM | Plateau repas 5 compartiments blanc | 340 × 250 mm | 35 mm | Blanc | 4 × 25 |
| 4 | COUV PR 5 C GM | Couvercle plateau repas 5 compartiments GM | 340 × 250 mm | 45 mm | Cristal | 4 × 25 |
| 5 | PR 4 C SEL | Plateau repas 4 compartiments blanc | 323 × 262 mm | 34 mm | Blanc | 4 × 50 |

1



PR 5 C ECO

2



COUV PR 5 C ECO

5



PR 4 C SEL

3



PR 5 C GM







4



COUV PR 5 C GM





| n° |  |  |  |  |  |  |
|----|--|--|---|--|--|--|
| 1 | B1CSJ | Boîte cristal 1 coquille Saint-Jacques | 290 × 138 mm | 52 mm | Translucide | 240 |
| 2 | B2CSJ | Boîte cristal 2 coquilles Saint-Jacques | 290 × 280 mm | 52 mm | Translucide | 120 |
| 3 | CSJ 1 GMN | Coquille plastique GM noire | 125 × 125 mm | 20 mm | Noir | 10 × 100 |



Coquille plastique et boîte pour coquille



1

B1CSJ



2

B2CSJ



3

CSJ 1 GMN

| n° |  |  |  |  |  |  |
|----|---|---|--|---|---|---|
| 1 | PT 140 | Part à tarte 140 PET | 134 × 105 mm | 40 mm | Cristal | 6 × 90 |
| 2 | PT 150 | Part à tarte 150 PET | 135 × 105 mm | 50 mm | Cristal | 6 × 90 |
| 3 | TRIANGLE SAND PM | Triangle sandwich PM | 180 × 67 mm | 90 mm | Cristal | 500 |
| 4 | TRIANGLE SAND GM | Triangle sandwich GM | 180 × 78 mm | 90 mm | Cristal | 500 |



Part de tarte et triangle sandwich



1

PT 140



2

PT 150



3

TRIANGLE SAND PM



4

TRIANGLE SAND GM

Assiette (OPS et PP)



| n° | | | | | | |
|----|---------------|--------------------------|----------|-------|---------|---------|
| 1 | ASPCN 175 OPS | Assiette creuse OPS | Ø 177 mm | 38 mm | Noir | 6 × 100 |
| 2 | ASPCN 175 PP | Assiette creuse PP | Ø 177 mm | 38 mm | Noir | 5 × 100 |
| 3 | PLN 200 NPP | Assiette creuse PP | Ø 225 mm | 38 mm | Noir | 5 × 100 |
| 4 | COUV PLN 200 | Couvercles pour assiette | Ø 200 mm | 35 mm | Cristal | 5 × 50 |
| 5 | DOME L2 | Dôme assiette | Ø 180 mm | 38 mm | Cristal | 6 × 100 |
| 6 | DOME L3 | Dôme assiette | Ø 225 mm | 35 mm | Cristal | 6 × 100 |



1

ASPCN 175 OPS



2

ASPCN 175 PP



3

PLN 200 PP



4

COUV PLN 200



5







DOME L2



6

DOME L3



| n° |  |  |  |  |  |  |  |  |
|----|---|---|---|---|---|---|---|---|
| 1 | BOL 350 PP | Bol 350 PP blanc | Ø 128 mm | 48 mm | Blanc | 6 × 100 | | |
| 2 | BOL 350 PP N | Bol 350 PP noir | Ø 128 mm | 48 mm | Noir | 6 × 100 | | |
| 3 | BOL 450 PP N | Bol 450 PP noir | Ø 128 mm | 57 mm | Noir | 6 × 100 | | |
| 4 | BOL 450 PP T | Bol 450 PP translucide | Ø 128 mm | 57 mm | Translucide | 6 × 100 | | |



BOL 350 PP



BOL 350 PP N



BOL 450 PP N



BOL 450 PP T

Pot fast



Ce produit est interdit à l'utilisation pour le liquide.

| n° | | | | | | | |
|----|---------------------|---|---------|--------|------------|---------|---------|
| 1 | POT FAST 25 | Pot fast 20/25 cl PET | Ø 78 mm | 89 mm | 200/250 ml | Cristal | 25 × 50 |
| 2 | POT FAST 30 | Pot fast 25/30 cl PET | Ø 78 mm | 108 mm | 250/300 ml | Cristal | 25 × 50 |
| 3 | POT FAST 35 | Pot fast 30/35 cl PET | Ø 78 mm | 124 mm | 300/350 ml | Cristal | 25 × 50 |
| 4 | POT FAST 30/45 | Pot fast 30/45 cl PET | Ø 95 mm | 107 mm | 300/450 ml | Cristal | 16 × 50 |
| 5 | POT FAST 40 | Pot fast 40 cl PET | Ø 95 mm | 124 mm | 400/550 ml | Cristal | 16 × 50 |
| 6 | POT FAST 50 | Pot fast 50 cl PET | Ø 95 mm | 150 mm | 500/650 ml | Cristal | 16 × 50 |
| 7 | COUV POT FAST 25 | Couvercle croisillon pour pot fast 25 à 35 cl | Ø 78 mm | 7 mm | – | Cristal | 25 × 50 |
| 8 | COUV POT FAST 40 | Couvercle croisillon pour pot fast 40 à 50 cl | Ø 95 mm | 7 mm | – | Cristal | 16 × 50 |
| 9 | DOME FAST 25 TROU | Dôme pour pot fast 25 à 35 cl avec trou | Ø 78 mm | 38 mm | – | Cristal | 25 × 50 |
| 10 | DOME FAST 25 S/TROU | Dôme pour pot fast 25 à 35 cl sans trou | Ø 78 mm | 38 mm | – | Cristal | 25 × 50 |
| 11 | DOME FAST 40 TROU | Dôme pour pot fast 40 à 50 cl avec trou | Ø 95 mm | 40 mm | – | Cristal | 16 × 50 |
| 12 | DOME FAST 40 S/TROU | Dôme pour pot fast 40 à 50 cl sans trou | Ø 95 mm | 40 mm | – | Cristal | 16 × 50 |



POT FAST 25



POT FAST 30



POT FAST 35



POT FAST 30/45



POT FAST 40



POT FAST 50



COUV POT FAST 25



COUV POT FAST 40



DOME FAST 25 TROU



DOME FAST 25 S/TROU



DOME FAST 40 TROU



DOME FAST 40 S/TROU

| n° |  |  |  |  |  |
|----|--|---|--|--|--|
| 1 | CO 180 RLUX | Couteau 180 cristal réutilisable | 180 mm | Cristal | 10 × 100 |
| 2 | FO 180 RLUX | Fourchette 180 cristal réutilisable | 180 mm | Cristal | 10 × 100 |
| 3 | CU 180 RLUX | Cuillère à soupe 180 cristal réutilisable | 180 mm | Cristal | 10 × 100 |
| 4 | CU 140 RLUX | Cuillère à dessert 140 cristal réutilisable | 140 mm | Cristal | 20 × 100 |
| 5 | KIT 2/1 RLUX | Fourchette 180 / Couteau 180 | - | Cristal | 250 |
| 6 | KIT 3/1 RLUX | Fourchette 180 / Couteau 180 / Serviette 2 plis | - | Cristal | 250 |
| 7 | KIT 4/1 RLUX | Fourchette 180 / Couteau 180 / Cuillère à dessert 125 / Serviette 2 plis | - | Cristal | 250 |
| 8 | KIT 6/1 RLUX | Fourchette 180 / Couteau 180 / Cuillère à dessert 140 / Serviette 2 plis / Sel & poivre | - | Cristal | 250 |



Couvert Rlux réutilisable

En conformité avec la législation en vigueur :

- réutilisables.
- résistent aux 3 cycles de migrations successives.



1

CO 180 RLUX



2

FO 180 RLUX



3

CU 180 RLUX



4

CU 140 RLUX



5

KIT 2/1 RLUX



6

KIT 3/1 RLUX



7

KIT 4/1 RLUX









8

KIT 6/1 RLUX

Plateau



| n° |  |  |  |  |  |  |
|----|---|---|---|---|---|---|
| 1 | PPIC 35 × 14 | Plateau prestige PM | 350 × 137 mm | 20 mm | Cristal | 18 × 2 |
| 2 | PPIC 35 × 28 | Plateau prestige GM | 350 × 275 mm | 20 mm | Cristal | 18 × 1 |
| 3 | PPIC 35 × 28 NOIR | Plateau prestige GM | 350 × 275 mm | 20 mm | Noir | 18 × 1 |



1

PPIC 35 × 14



2

PPIC 35 × 28



3

PPIC 35 × 28 NOIR



| | | | | | | | | |
|----|----------|------------------------------------|------------|-------|---|------------|---------|--|
| n° | | | | | | | | |
| 1 | TRIANGLE | Mise en bouche triangle vert d'eau | 80 × 80 mm | 20 mm | - | Vert d'eau | 30 × 24 | |



Verrine injectée cristal



| n° | | | | | | | |
|----|-------------------|--|-------------|-------|----------|---------|---------|
| 1 | VR 2 | Verrine rond 2 cl | Ø 37 mm | 42 mm | 2 cl | Cristal | 54 × 50 |
| 2 | VR 5 | Verrine rond 5 cl | Ø 42 mm | 52 mm | 5/6 cl | Cristal | 40 × 50 |
| 3 | VR 6 | Verrine rond 6 cl | Ø 44 mm | 58 mm | 6/7 cl | Cristal | 40 × 40 |
| 4 | VR 7 | Verrine rond 7 cl | Ø 49,5 mm | 65 mm | 7/8 cl | Cristal | 45 × 45 |
| 5 | VR 10 | Verrine rond 10 cl | Ø 54 mm | 75 mm | 10/12 cl | Cristal | 35 × 40 |
| 6 | SPIRAL CRISTAL | Mise en bouche verrine spiral cristal | Ø 44 mm | 69 mm | 7 cl | Cristal | 6 × 50 |
| 7 | ART DECO CRISTAL | Mise en bouche verrine art déco cristal | 55 × 55 mm | 51 mm | 7 cl | Cristal | 15 × 20 |
| 8 | CU 120 ASIA | Mise en bouche cuillère chinoise 120 | 120 × 41 mm | 37 mm | - | Cristal | 6 × 50 |
| 9 | CU 120 ASIA NOIRE | Mise en bouche cuillère chinoise 120 noire | 120 × 41 mm | 37 mm | - | Noir | 6 × 50 |
| 10 | MBC | Mise en bouche cassolette ovale | Ø 80 mm | 14 mm | 4 cl | Cristal | 20 × 50 |
| 11 | MBK | Mise en bouche carrée | 68 × 68 mm | 15 mm | 4 cl | Cristal | 20 × 50 |
| 12 | FLEUR CRISTAL | Mise en bouche fleur cristal | 55 × 60 mm | 45 mm | 6,5 cl | Cristal | 30 × 24 |

1



VR 2

2



VR 5

3



VR 6

4



VR 7

5



VR 10

6



SPIRAL CRISTAL

7



ART DECO CRISTAL

8



CU 120 ASIA

9



CU 120 ASIA NOIRE

10



MBC

11



MBK

12



FLEUR CRISTAL











| n° | | | | | | | | |
|----|------------------|---------------------------------|------------|------------|--------|---------|---------|--|
| 13 | TULIPE | Mise en bouche tulipe | 63 × 70 mm | 45 mm | 7,7 cl | Cristal | 20 × 50 | |
| 14 | EVASE 6 | Verrine évasé cristal 6 cl | Ø 47 mm | 63 mm | 6 cl | Cristal | 24 × 12 | |
| 15 | BAQUET 6 | Mise en bouche baquet 6 cl | 67 × 50 mm | 30 mm | 6 cl | Cristal | 32 × 20 | |
| 16 | BIZO 6,5 | Mise en bouche bizo 6,5 cl | Ø 40 mm | 58 – 82 mm | 6,5 cl | Cristal | 27 × 12 | |
| 17 | HEXAGONE CRISTAL | Mise en bouche hexagone cristal | 46 × 55 mm | 46 mm | 5,5 cl | Cristal | 36 × 24 | |
| 18 | COUPOLE CRISTAL | Mise en bouche coupole cristal | Ø 72 mm | 34 mm | 8 cl | Cristal | 30 × 24 | |
| 19 | COUV COUPOLE | Couvercle pour coupole | Ø 72 mm | 28 mm | – | Cristal | 30 × 24 | |
| 20 | BOULE | Mise en bouche boule cristal | Ø 58 mm | 42 mm | 8 cl | Cristal | 25 × 12 | |



Verrine injectée cristal



|  | n° |  |  |  |  |  |  |  |
|---|----|---|---|---|---|---|---|---|
| | 1 | BODEGA PM | Verrine bodega 14 cl | Ø 77 mm | 57 mm | 14 cl | Cristal | 15 × 20 |
| | 2 | BODEGA GM | Verrine bodega 25 cl | Ø 82 mm | 60 mm | 25 cl | Cristal | 15 × 20 |
| | 3 | EVASE 15 | Verrine évasé 15 cl | Ø 65 mm | 79 mm | 19 cl | Cristal | 30 × 10 |
| | 4 | EVASE 25 | Verrine évasé 25 cl | Ø 79 mm | 97 mm | 24 cl | Cristal | 30 × 10 |
| | 5 | COUV BODEGA PM | Couvercle pour bodega 14 | Ø 83 mm | 8 mm | – | Cristal | 5 × 60 |
| | 6 | COUV BODEGA GM | Couvercle pour bodega 25 & évasé 25 | Ø 90 mm | 8 mm | – | Cristal | 15 × 20 |
| | 7 | COUV EVASE 15 | Couvercle pour verrine évasé 15 | Ø 78 mm | 8 mm | – | Cristal | 5 × 60 |



1 BODEGA PM



2 BODEGA GM



3 EVASE 15



4 EVASE 25









5 COUV BODEGA PM



6 COUV BODEGA GM



7 COUV EVASE 15

| n° |  |  |  |  |  |  |  |
|----|--|--|--|--|--|--|--|
| 8 | COADRY 6 | Mise en bouche coadry 6 cl | 48 × 48 mm | 46 mm | 6 cl | Cristal | 30 × 30 |
| 9 | COADRY 16 | Mise en bouche coadry 16 cl | 56 × 56 mm | 75 mm | 16 cl | Cristal | 21 × 12 |
| 10 | COADRY 20 | Mise en bouche coadry 20 cl | 70 × 70 mm | 73 mm | 20 cl | Cristal | 41 × 20 |
| 11 | COUV COADRY 6 | Couvercle pour coadry 6 cl | 57 × 57 mm | 17 mm | - | Cristal | 60 × 15 |
| 12 | COUV COADRY 16 | Couvercle pour coadry 16 cl | 66 × 66 mm | 18 mm | - | Cristal | 7 × 36 |
| 13 | COUV COADRY 20 | Couvercle pour coadry 20 cl | 70 × 70 mm | 18 mm | - | Cristal | 41 × 20 |



Verrine injectée cristal

Pensez-y !
Couverts verrines.

La cuillère CU 80 Bambou
(p.52)

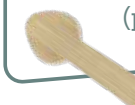

8

COADRY 6



9

COADRY 16



10

COADRY 20



11

COUV COADRY 6









12

COUV COADRY 16



13

COUV COADRY 20

| n° |  |  |  |  |  |  |  |
|----|---|---|---|---|---|---|---|
| 1 | VP 5 | Verrine à pied 5 cl | Ø 38 mm | 63 mm | 5 cl | Cristal | 70 × 20 |
| 2 | VP 10 | Verrine à pied 10 cl | Ø 50 mm | 85 mm | 10 cl | Cristal | 40 × 15 |
| 3 | VP 17 | Verre à pied 17 cl | Ø 59 mm | 95,5 mm | 17 cl | Cristal | 24 × 10 |



Verrine et verre injectés cristal



1

VP 5



2

VP 10



3

VP 17



Flûte, verre réutilisables



| n° | | | | | | | | |
|----|---------------|------------------------|---------|--------|---------|---------|---------|--|
| 1 | VLD 20 | Verre long drink 20 cl | Ø 60 mm | 103 mm | 20 cl | Cristal | 42 × 10 | |
| 2 | VLD 30 | Verre long drink 30 cl | Ø 61 mm | 140 mm | 30 cl | Cristal | 42 × 10 | |
| 3 | FL 10 | Flûte monobloc 10 cl | Ø 48 mm | 175 mm | 10 cl | Cristal | 23 × 10 | |
| 4 | FL 13 CRISTAL | Flûte monobloc cristal | Ø 50 mm | 178 mm | 13,5 cl | Cristal | 20 × 10 | |

1



VLD 20

2



VLD 30

3



FL 10

4



FL 13 CRISTAL



Flûte, verre à eau, verre à vin réutilisables (PS injecté)



n°



| n° | | | | | | | | |
|----|---------------|-----------------------------|---------|--------|---------|---------|---------|--|
| 1 | FL 13 CRISTAL | Flûte monobloc cristal | Ø 50 mm | 178 mm | 13,5 cl | Cristal | 20 × 10 | |
| 2 | VE 20 CRISTAL | Verre à eau cristal | Ø 72 mm | 145 mm | 20 cl | Cristal | 22 × 6 | |
| 3 | VV 15 CRISTAL | Verre à vin cristal | Ø 66 mm | 133 mm | 15 cl | Cristal | 28 × 6 | |
| 4 | FL 13 BLEU | Flûte monobloc cristal bleu | Ø 50 mm | 178 mm | 13,5 cl | ◆ | 20 × 10 | |
| 5 | VE 20 BLEU | Verre à eau cristal bleu | Ø 72 mm | 145 mm | 20 cl | ◆ | 22 × 6 | |
| 6 | VV 15 BLEU | Verre à vin cristal bleu | Ø 66 mm | 133 mm | 15 cl | ◆ | 28 × 6 | |



design & création



1

FL 13 CRISTAL



2

VE 20 CRISTAL



3

VV 15 CRISTAL



4

FL 13 BLEU



5

VE 20 BLEU



6

VV 15 BLEU

Flûte, verre à eau, verre à vin réutilisables (PS injecté)



| n° | | | | | | | |
|----|---------------------|------------------------------|---------|--------|---------|---|---------|
| 7 | FL 13 CRISTAL ROUGE | Flûte monobloc cristal rouge | Ø 50 mm | 178 mm | 13,5 cl | ◆ | 20 × 10 |
| 8 | VE 20 CRISTAL ROUGE | Verre à eau cristal rouge | Ø 72 mm | 145 mm | 20 cl | ◆ | 22 × 6 |
| 9 | VV 15 CRISTAL ROUGE | Verre à vin cristal rouge | Ø 66 mm | 133 mm | 15 cl | ◆ | 28 × 6 |



7

FL 13 CRISTAL ROUGE



8

VE 20 CRISTAL ROUGE



9

VV 15 CRISTAL ROUGE



Flûte, verre à eau, verre à vin réutilisables (PS injecté)



n°



| n° | | | | | | | |
|----|-------------|----------------------|---------|--------|---------|---|---------|
| 10 | FL 13 EBENE | Flûte monobloc ébène | Ø 50 mm | 178 mm | 13,5 cl | ◆ | 20 × 10 |
| 11 | VE 20 EBENE | Verre à eau ébène | Ø 72 mm | 145 mm | 20 cl | ◆ | 22 × 6 |
| 12 | VV 15 EBENE | Verre à vin ébène | Ø 66 mm | 133 mm | 15 cl | ◆ | 28 × 6 |
| 13 | FL 13 NACRE | Flûte monobloc nacré | Ø 50 mm | 178 mm | 13,5 cl | ◆ | 20 × 10 |
| 14 | VE 20 NACRE | Verre à eau nacré | Ø 72 mm | 145 mm | 20 cl | ◆ | 22 × 6 |
| 15 | VV 15 NACRE | Verre à vin nacré | Ø 66 mm | 133 mm | 15 cl | ◆ | 28 × 6 |



design & création



10

FL 13 EBENE



11

VE 20 EBENE



12

VV 15 EBENE



13

FL 13 NACRE



14

VE 20 NACRE



15

VV 15 NACRE



Flûte, verre à eau, verre à vin réutilisables (PS injecté)



design & création



n°



| n° | | | | | | | |
|----|----------------|-------------------------|---------|--------|---------|---|---------|
| 16 | FL 13 CARMIN | Flûte monobloc carmin | Ø 50 mm | 178 mm | 13,5 cl | ◆ | 20 × 10 |
| 17 | VE 20 CARMIN | Verre à eau carmin | Ø 72 mm | 145 mm | 20 cl | ◆ | 22 × 6 |
| 18 | VV 15 CARMIN | Verre à vin carmin | Ø 66 mm | 133 mm | 15 cl | ◆ | 28 × 6 |
| 19 | FL 13 CHOCOLAT | Flûte monobloc chocolat | Ø 50 mm | 178 mm | 13,5 cl | ◆ | 20 × 10 |
| 20 | VE 20 CHOCOLAT | Verre à eau chocolat | Ø 72 mm | 145 mm | 20 cl | ◆ | 22 × 6 |
| 21 | VV 15 CHOCOLAT | Verre à vin chocolat | Ø 66 mm | 133 mm | 15 cl | ◆ | 28 × 6 |

16



FL 13 CARMIN

17



VE 20 CARMIN

18



VV 15 CARMIN

19



FL 13 CHOCOLAT

20















VE 20 CHOCOLAT

21



VV 15 CHOCOLAT

| n° |  |  |  |  |  |  |  |
|----|--|--|--|--|--|---|--|
| 22 | FL 13 MAGENTA | Flûte monobloc magenta | Ø 50 mm | 178 mm | 13,5 cl |  | 20 × 10 |
| 23 | VE 20 MAGENTA | Verre à eau magenta | Ø 72 mm | 145 mm | 20 cl |  | 22 × 6 |
| 24 | VV 15 MAGENTA | Verre à vin magenta | Ø 66 mm | 133 mm | 15 cl |  | 28 × 6 |
| 25 | FL 13 ANIS | Flûte monobloc anis | Ø 50 mm | 178 mm | 13,5 cl |  | 20 × 10 |
| 26 | VE 20 ANIS | Verre à eau anis | Ø 72 mm | 145 mm | 20 cl |  | 22 × 6 |
| 27 | VV 15 ANIS | Verre à vin anis | Ø 66 mm | 133 mm | 15 cl |  | 28 × 6 |



Flûte, verre à eau, verre à vin réutilisables (PS injecté)



design & création



22

FL 13 MAGENTA



23

VE 20 MAGENTA



24

VV 15 MAGENTA



25

FL 13 ANIS



26

VE 20 ANIS



27

VV 15 ANIS

Flûte, verre à eau, verre à vin réutilisables (PS injecté)



n°



| | | | | | | | |
|----|-----------------|--------------------------|---------|--------|---------|---|---------|
| 28 | FL 13 TURQUOISE | Flûte monobloc turquoise | Ø 50 mm | 178 mm | 13,5 cl | ◆ | 20 × 10 |
| 29 | VE 20 TURQUOISE | Verre à eau turquoise | Ø 72 mm | 145 mm | 20 cl | ◆ | 22 × 6 |
| 30 | VV 15 TURQUOISE | Verre à vin turquoise | Ø 66 mm | 133 mm | 15 cl | ◆ | 28 × 6 |
| 31 | FL 13 ORANGE | Flûte monobloc orange | Ø 50 mm | 178 mm | 13,5 cl | ◆ | 20 × 10 |
| 32 | VE 20 ORANGE | Verre à eau orange | Ø 72 mm | 145 mm | 20 cl | ◆ | 22 × 6 |
| 33 | VV 15 ORANGE | Verre à vin orange | Ø 66 mm | 133 mm | 15 cl | ◆ | 28 × 6 |



design & création



28

FL 13 TURQUOISE



29

VE 20 TURQUOISE



30

VV 15 TURQUOISE



31

FL 13 ORANGE















32

VE 20 ORANGE



33

VV 15 ORANGE

| n° |  |  |  |  |  |  |  |
|----|--|--|--|--|--|---|--|
| 34 | FL 13 CIEL | Flûte monobloc ciel | Ø 50 mm | 178 mm | 13,5 cl |  | 20 × 10 |
| 35 | VE 20 CIEL | Verre à eau ciel | Ø 72 mm | 145 mm | 20 cl |  | 22 × 6 |
| 36 | VV 15 CIEL | Verre à vin ciel | Ø 66 mm | 133 mm | 15 cl |  | 28 × 6 |
| 37 | FL 13 ROSE | Flûte monobloc rose | Ø 50 mm | 178 mm | 13,5 cl |  | 20 × 10 |
| 38 | VE 20 ROSE | Verre à eau rose | Ø 72 mm | 145 mm | 20 cl |  | 22 × 6 |
| 39 | VV 15 ROSE | Verre à vin rose | Ø 66 mm | 133 mm | 15 cl |  | 28 × 6 |



Flûte, verre à eau, verre à vin réutilisables (PS injecté)



design & création



34

FL 13 CIEL



35

VE 20 CIEL



36

VV 15 CIEL

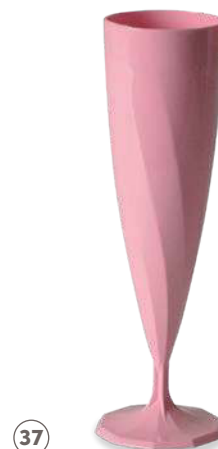

37

FL 13 ROSE



38

VE 20 ROSE



39

VV 15 ROSE

Flûte, verre à eau, verre à vin réutilisables (PS injecté)



n°



| n° | | | | | | | |
|----|----------------|-------------------------|---------|--------|---------|---|---------|
| 40 | FL 13 EMERAUDE | Flûte monobloc émeraude | Ø 50 mm | 178 mm | 13,5 cl | ◆ | 20 × 10 |
| 41 | VE 20 EMERAUDE | Verre à eau émeraude | Ø 72 mm | 145 mm | 20 cl | ◆ | 22 × 6 |
| 42 | VV 15 EMERAUDE | Verre à vin émeraude | Ø 66 mm | 133 mm | 15 cl | ◆ | 28 × 6 |
| 43 | FL 13 POURPRE | Flûte monobloc pourpre | Ø 50 mm | 178 mm | 13,5 cl | ◆ | 20 × 10 |
| 44 | VE 20 POURPRE | Verre à eau pourpre | Ø 72 mm | 145 mm | 20 cl | ◆ | 22 × 6 |
| 45 | VV 15 POURPRE | Verre à vin pourpre | Ø 66 mm | 133 mm | 15 cl | ◆ | 28 × 6 |



design & création



40



FL 13 EMERAUDE

41



VE 20 EMERAUDE

42



VV 15 EMERAUDE

43



FL 13 POURPRE

44



VE 20 POURPRE

45









VV 15 POURPRE

Flûte, verre à eau, verre à vin réutilisables (PS injecté)



design & création

| n° |  |  |  |  |  |  |  |
|----|---|---|---|---|---|---|---|
| 46 | FL 13 ARGENT | Flûte monobloc argent | Ø 50 mm | 178 mm | 13,5 cl | ◆ | 20 × 10 |
| 47 | VE 20 ARGENT | Verre à eau cristal argent | Ø 72 mm | 145 mm | 20 cl | ◆ | 22 × 6 |
| 48 | VV 15 ARGENT | Verre à vin cristal argent | Ø 66 mm | 133 mm | 15 cl | ◆ | 28 × 6 |



46



FL 13 ARGENT

47



VE 20 ARGENT

48



VV 15 ARGENT

Flûte, verre à eau, verre à vin réutilisables (PS injecté)



& design
création



| n° | | | | | | | |
|----|----------|------------------------|---------|--------|---------|---|---------|
| 49 | FL 13 OR | Flûte monobloc or | Ø 50 mm | 178 mm | 13,5 cl | ◆ | 20 × 10 |
| 50 | VE 20 OR | Verre à eau cristal or | Ø 72 mm | 145 mm | 20 cl | ◆ | 22 × 6 |
| 51 | VV 15 OR | Verre à vin cristal or | Ø 66 mm | 133 mm | 15 cl | ◆ | 28 × 6 |

49



FL 13 OR

50



VE 20 OR

51



VV 15 OR



Assiette carrée injectée 180 × 180



n°



| n° | | | | | | |
|----|-----------------|--|--------------|-------|---------|--------|
| 1 | ACP 180 CRISTAL | Assiette carrée prestige cristal | 180 × 180 mm | 17 mm | Cristal | 6 × 12 |
| 2 | ACP 180 BLEUE | Assiette carrée prestige cristal bleu | 180 × 180 mm | 17 mm | ◆ | 6 × 12 |
| 3 | ACP 180 ROUGE | Assiette carrée prestige cristal rouge | 180 × 180 mm | 17 mm | ◆ | 6 × 12 |
| 4 | ACP 180 EBENE | Assiette carrée prestige ébène | 180 × 180 mm | 17 mm | ◆ | 6 × 12 |
| 5 | ACP 180 NACRE | Assiette carrée prestige nacre | 180 × 180 mm | 17 mm | ◆ | 6 × 12 |
| 6 | ACP 180 CARMIN | Assiette carrée prestige carmin | 180 × 180 mm | 17 mm | ◆ | 6 × 12 |



design & création



1

ACP 180 CRISTAL



2

ACP 180 BLEUE



3

ACP 180 ROUGE



4

ACP 180 EBENE















5

ACP 180 NACRE



6

ACP 180 CARMIN

| n° |  |  |  |  |  |  |
|----|--|--|--|--|---|--|
| 7 | ACP 180 CHOCOLAT | Assiette carrée prestige chocolat | 180 × 180 mm | 17 mm |  | 6 × 12 |
| 8 | ACP 180 MAGENTA | Assiette carrée prestige magenta | 180 × 180 mm | 17 mm |  | 6 × 12 |
| 9 | ACP 180 ANIS | Assiette carrée prestige anis | 180 × 180 mm | 17 mm |  | 6 × 12 |
| 10 | ACP 180 TURQUOISE | Assiette carrée prestige turquoise | 180 × 180 mm | 17 mm |  | 6 × 12 |
| 11 | ACP 180 ORANGE | Assiette carrée prestige orange | 180 × 180 mm | 17 mm |  | 6 × 12 |
| 12 | ACP 180 EMERAUDE | Assiette carrée prestige émeraude | 180 × 180 mm | 17 mm |  | 6 × 12 |



Assiette carrée injectée 180 × 180



7

ACP 180 CHOCOLAT



8

ACP 180 MAGENTA



9

ACP 180 ANIS



10

ACP 180 TURQUOISE



11

ACP 180 ORANGE



12

ACP 180 EMERAUDE

Assiette carrée injectée 180 × 180



n°



| n° | | | | | | |
|----|-----------------|----------------------------------|--------------|-------|---------|--------|
| 13 | ACP 180 ROSE | Assiette carrée prestige rose | 180 × 180 mm | 17 mm | | 6 × 12 |
| 14 | ACP 180 CIEL | Assiette carrée prestige ciel | 180 × 180 mm | 17 mm | | 6 × 12 |
| 15 | ACP 180 POURPRE | Assiette carrée prestige pourpre | 180 × 180 mm | 17 mm | | 6 × 12 |
| 16 | ACP 180 ARGENT | Assiette carrée prestige argent | 180 × 180 mm | 17 mm | | 6 × 12 |
| 17 | ACP 180 OR | Assiette carrée prestige or | 180 × 180 mm | 17 mm | | 6 × 12 |
| 18 | COUV ATC 180 | Couvercle assiette carrée APET | 190 × 190 mm | 40 mm | Cristal | 4 × 48 |



design & création



13

ACP 180 ROSE



14

ACP 180 CIEL



15

ACP 180 POURPRE



16

ACP 180 ARGENT



17

ACP 180 OR



18

COUV ATC 180



Assiette carrée injectée 240 × 240



n°



| n° | | | | | | |
|----|-----------------|--|--------------|-------|---------|--------|
| 1 | ACP 240 CRISTAL | Assiette carrée prestige cristal | 240 × 240 mm | 18 mm | Cristal | 8 × 12 |
| 2 | ACP 240 BLEUE | Assiette carrée prestige cristal bleu | 240 × 240 mm | 18 mm | ◆ | 8 × 12 |
| 3 | ACP 240 ROUGE | Assiette carrée prestige cristal rouge | 240 × 240 mm | 18 mm | ◆ | 8 × 12 |
| 4 | ACP 240 EBENE | Assiette carrée prestige ébène | 240 × 240 mm | 18 mm | ◆ | 8 × 12 |
| 5 | ACP 240 NACRE | Assiette carrée prestige nacre | 240 × 240 mm | 18 mm | ◆ | 8 × 12 |
| 6 | ACP 240 CARMIN | Assiette carrée prestige carmin | 240 × 240 mm | 18 mm | ◆ | 8 × 12 |



design & création



1

ACP 240 CRISTAL



2

ACP 240 BLEUE



3

ACP 240 ROUGE



4

ACP 240 EBENE



5













ACP 240 NACRE



6

ACP 240 CARMIN

Assiette carrée injectée 240 × 240

| n° |  |  |  |  |  |  |
|----|--|--|--|--|---|--|
| 7 | ACP 240 CHOCOLAT | Assiette carrée prestige chocolat | 240 × 240 mm | 18 mm |  | 8 × 12 |
| 8 | ACP 240 MAGENTA | Assiette carrée prestige magenta | 240 × 240 mm | 18 mm |  | 8 × 12 |
| 9 | ACP 240 ANIS | Assiette carrée prestige anis | 240 × 240 mm | 18 mm |  | 8 × 12 |
| 10 | ACP 240 TURQUOISE | Assiette carrée prestige turquoise | 240 × 240 mm | 18 mm |  | 8 × 12 |
| 11 | ACP 240 ORANGE | Assiette carrée prestige orange | 240 × 240 mm | 18 mm |  | 8 × 12 |
| 12 | ACP 240 EMERAUDE | Assiette carrée prestige émeraude | 240 × 240 mm | 18 mm |  | 8 × 12 |



7

ACP 240 CHOCOLAT



8

ACP 240 MAGENTA



9

ACP 240 ANIS



10

ACP 240 TURQUOISE



11

ACP 240 ORANGE



12

ACP 240 EMERAUDE

Assiette carrée injectée 240 × 240



| n° | | | | | | |
|----|-----------------|----------------------------------|--------------|-------|---------|--------|
| 13 | ACP 240 ROSE | Assiette carrée prestige rose | 240 × 240 mm | 18 mm | | 8 × 12 |
| 14 | ACP 240 CIEL | Assiette carrée prestige ciel | 240 × 240 mm | 18 mm | | 8 × 12 |
| 15 | ACP 240 POURPRE | Assiette carrée prestige pourpre | 240 × 240 mm | 18 mm | | 8 × 12 |
| 16 | ACP 240 ARGENT | Assiette carrée prestige argent | 240 × 240 mm | 18 mm | | 8 × 12 |
| 17 | ACP 240 OR | Assiette carrée prestige or | 240 × 240 mm | 18 mm | | 8 × 12 |
| 18 | COUV ATC 240 | Couvercle assiette carrée APET | 240 × 240 mm | 40 mm | Cristal | 4 × 48 |



design & création



13

ACP 240 ROSE



14

ACP 240 CIEL



15

ACP 240 POURPRE



16

ACP 240 ARGENT



17

ACP 240 OR



18

COUV ATC 240

| n° |  |  |  |  |  |  |
|----|--|--|--|--|---|--|
| 1 | SACP 300 CRISTAL | Sous-assiette carrée prestige cristal | 300 × 300 mm | 15 mm | Cristal | 18 × 4 |
| 2 | SACP 300 EBENE | Sous-assiette carrée prestige ébène | 300 × 300 mm | 15 mm |  | 18 × 4 |
| 3 | SACP 300 NACRE | Sous-assiette carrée prestige nacre | 300 × 300 mm | 15 mm |  | 18 × 4 |
| 4 | SACP 300 CARMIN | Sous-assiette carrée prestige carmin | 300 × 300 mm | 15 mm |  | 18 × 4 |
| 5 | SACP 300 CHOCOLAT | Sous-assiette carrée prestige chocolat | 300 × 300 mm | 15 mm |  | 18 × 4 |
| 6 | SACP 300 MAGENTA | Sous-assiette carrée prestige magenta | 300 × 300 mm | 15 mm |  | 18 × 4 |
| 7 | SACP 300 ANIS | Sous-assiette carrée prestige anis | 300 × 300 mm | 15 mm |  | 18 × 4 |
| 8 | SACP 300 TURQUOISE | Sous-assiette carrée prestige turquoise | 300 × 300 mm | 15 mm |  | 18 × 4 |



Sous-assiette carrée 300 × 300



1

SACP 300 CRISTAL



2

SACP 300 EBENE



3

SACP 300 NACRE



4

SACP 300 CARMIN



5

SACP 300 CHOCOLAT



6

SACP 300 MAGENTA



7

SACP 300 ANIS



8

SACP 300 TURQUOISE

Sous-assiette carrée 300 × 300



n°



| n° | | | | | | |
|----|------------------|---------------------------------------|--------------|-------|---|--------|
| 9 | SACP 300 ORANGE | Sous-assiette carrée prestige orange | 300 × 300 mm | 15 mm | ◆ | 18 × 4 |
| 10 | SACP 300 ROSE | Sous-assiette carrée prestige rose | 300 × 300 mm | 15 mm | ◆ | 18 × 4 |
| 11 | SACP 300 CIEL | Sous-assiette carrée prestige ciel | 300 × 300 mm | 15 mm | ◆ | 18 × 4 |
| 12 | SACP 300 POURPRE | Sous-assiette carrée prestige pourpre | 300 × 300 mm | 15 mm | ◆ | 18 × 4 |
| 13 | SACP 300 ARGENT | Sous-assiette carrée prestige argent | 300 × 300 mm | 15 mm | ◆ | 18 × 4 |
| 14 | SACP 300 OR | Sous-assiette carrée prestige or | 300 × 300 mm | 15 mm | ◆ | 18 × 4 |



design
& création



9

SACP 300 ORANGE



10

SACP 300 ROSE



11

SACP 300 CIEL



12

SACP 300 POURPRE



13

SACP 300 ARGENT



14

SACP 300 OR



Assiette ronde injectée Ø 190



n°



| n° | | | | | | |
|----|-----------------|---------------------------------------|----------|-------|---------|--------|
| 1 | ARP 190 CRISTAL | Assiette ronde prestige cristal | Ø 190 mm | 11 mm | Cristal | 8 × 12 |
| 2 | ARP 190 BLEUE | Assiette ronde prestige cristal bleue | Ø 190 mm | 11 mm | ◆ | 8 × 12 |
| 3 | ARP 190 ROUGE | Assiette ronde prestige cristal rouge | Ø 190 mm | 11 mm | ◆ | 8 × 12 |
| 4 | ARP 190 EBENE | Assiette ronde prestige ébène | Ø 190 mm | 11 mm | ◆ | 8 × 12 |
| 5 | ARP 190 NACRE | Assiette ronde prestige nacre | Ø 190 mm | 11 mm | ◆ | 8 × 12 |
| 6 | ARP 190 CARMIN | Assiette ronde prestige carmin | Ø 190 mm | 11 mm | ◆ | 8 × 12 |



ARP 190 CRISTAL



ARP 190 BLEUE



ARP 190 ROUGE



ARP 190 EBENE



ARP 190 NACRE



ARP 190 CARMIN

| n° |  |  |  |  |  |  |
|----|--|--|--|--|---|--|
| 7 | ARP 190 CHOCOLAT | Assiette ronde prestige chocolat | Ø 190 mm | 11 mm |  | 8 × 12 |
| 8 | ARP 190 MAGENTA | Assiette ronde prestige magenta | Ø 190 mm | 11 mm |  | 8 × 12 |
| 9 | ARP 190 ANIS | Assiette ronde prestige anis | Ø 190 mm | 11 mm |  | 8 × 12 |
| 10 | ARP 190 TURQUOISE | Assiette ronde prestige turquoise | Ø 190 mm | 11 mm |  | 8 × 12 |
| 11 | ARP 190 ORANGE | Assiette ronde prestige orange | Ø 190 mm | 11 mm |  | 8 × 12 |
| 12 | ARP 190 EMERAUDE | Assiette ronde prestige émeraude | Ø 190 mm | 11 mm |  | 8 × 12 |



Assiette ronde injectée Ø 190



7



ARP 190 CHOCOLAT

8



ARP 190 MAGENTA

9



ARP 190 ANIS

10



ARP 190 TURQUOISE

11



ARP 190 ORANGE

12



ARP 190 EMERAUDE

Assiette ronde injectée Ø 190



n°



| n° | | | | | | |
|----|-----------------|---------------------------------|----------|-------|---|--------|
| 13 | ARP 190 ROSE | Assiette ronde prestige rose | Ø 190 mm | 11 mm | ◆ | 8 × 12 |
| 14 | ARP 190 CIEL | Assiette ronde prestige ciel | Ø 190 mm | 11 mm | ◆ | 8 × 12 |
| 15 | ARP 190 POURPRE | Assiette ronde prestige pourpre | Ø 190 mm | 11 mm | ◆ | 8 × 12 |
| 16 | ARP 190 ARGENT | Assiette ronde prestige argent | Ø 190 mm | 11 mm | ◆ | 8 × 12 |
| 17 | ARP 190 OR | Assiette ronde prestige or | Ø 190 mm | 11 mm | ◆ | 8 × 12 |



design & création



13

ARP 190 ROSE



14

ARP 190 CIEL



15

ARP 190 POURPRE



16

ARP 190 ARGENT



17

ARP 190 OR



Assiette ronde injectée Ø 240



n°



| n° | | | | | | |
|----|-----------------|---------------------------------------|----------|-------|---------|---------|
| 1 | ARP 240 CRISTAL | Assiette ronde prestige cristal | Ø 240 mm | 12 mm | Cristal | 11 × 12 |
| 2 | ARP 240 BLEUE | Assiette ronde prestige cristal bleue | Ø 240 mm | 12 mm | ◆ | 11 × 12 |
| 3 | ARP 240 ROUGE | Assiette ronde prestige cristal rouge | Ø 240 mm | 12 mm | ◆ | 11 × 12 |
| 4 | ARP 240 EBENE | Assiette ronde prestige ébène | Ø 240 mm | 12 mm | ◆ | 11 × 12 |
| 5 | ARP 240 NACRE | Assiette ronde prestige nacre | Ø 240 mm | 12 mm | ◆ | 11 × 12 |
| 6 | ARP 240 CARMIN | Assiette ronde prestige carmin | Ø 240 mm | 12 mm | ◆ | 11 × 12 |



design & création



1

ARP 240 CRISTAL



2

ARP 240 BLEUE



3

ARP 240 ROUGE



4

ARP 240 EBENE



5

ARP 240 NACRE



6

ARP 240 CARMIN

| n° |  |  |  |  |  |  |
|----|--|--|--|--|---|--|
| 7 | ARP 240 CHOCOLAT | Assiette ronde prestige chocolat | Ø 240 mm | 12 mm |  | 11 x 12 |
| 8 | ARP 240 MAGENTA | Assiette ronde prestige magenta | Ø 240 mm | 12 mm |  | 11 x 12 |
| 9 | ARP 240 ANIS | Assiette ronde prestige anis | Ø 240 mm | 12 mm |  | 11 x 12 |
| 10 | ARP 240 TURQUOISE | Assiette ronde prestige turquoise | Ø 240 mm | 12 mm |  | 11 x 12 |
| 11 | ARP 240 ORANGE | Assiette ronde prestige orange | Ø 240 mm | 12 mm |  | 11 x 12 |
| 12 | ARP 240 EMERAUDE | Assiette ronde prestige émeraude | Ø 240 mm | 12 mm |  | 11 x 12 |



Assiette ronde injectée Ø 240



7



ARP 240 CHOCOLAT

8



ARP 240 MAGENTA

9



ARP 240 ANIS

10



ARP 240 TURQUOISE

11



ARP 240 ORANGE

12



ARP 240 EMERAUDE

Assiette ronde injectée Ø 240



| n° | | | | | | |
|----|-----------------|---------------------------------|----------|-------|--|---------|
| 13 | ARP 240 ROSE | Assiette ronde prestige rose | Ø 240 mm | 12 mm | | 11 × 12 |
| 14 | ARP 240 CIEL | Assiette ronde prestige ciel | Ø 240 mm | 12 mm | | 11 × 12 |
| 15 | ARP 240 POURPRE | Assiette ronde prestige pourpre | Ø 240 mm | 12 mm | | 11 × 12 |
| 16 | ARP 240 ARGENT | Assiette ronde prestige argent | Ø 240 mm | 12 mm | | 11 × 12 |
| 17 | ARP 240 OR | Assiette ronde prestige or | Ø 240 mm | 12 mm | | 11 × 12 |



13

ARP 240 ROSE



14

ARP 240 CIEL



15

ARP 240 POURPRE



16

ARP 240 ARGENT



17

ARP 240 OR



Sous-assiette ronde injectée Ø 300



n°



| n° | | | | | | |
|----|-------------------|---------------------------------------|----------|-------|---------|--------|
| 1 | SARP 300 CRISTAL | Sous-assiette ronde prestige cristal | Ø 300 mm | 10 mm | Cristal | 18 × 4 |
| 2 | SARP 300 EBENE | Sous-assiette ronde prestige ébène | Ø 300 mm | 10 mm | ◆ | 18 × 4 |
| 3 | SARP 300 NACRE | Sous-assiette ronde prestige nacre | Ø 300 mm | 10 mm | ◆ | 18 × 4 |
| 4 | SARP 300 CARMIN | Sous-assiette ronde prestige carmin | Ø 300 mm | 10 mm | ◆ | 18 × 4 |
| 5 | SARP 300 CHOCOLAT | Sous-assiette ronde prestige chocolat | Ø 300 mm | 10 mm | ◆ | 18 × 4 |
| 6 | SARP 300 MAGENTA | Sous-assiette ronde prestige magenta | Ø 300 mm | 10 mm | ◆ | 18 × 4 |



design
& création



1

SARP 300 CRISTAL



2

SARP 300 EBENE



3

SARP 300 NACRE



4

SARP 300 CARMIN













5

SARP 300 CHOCOLAT



6

SARP 300 MAGENTA

| n° |  |  |  |  |  |  |
|----|--|--|--|--|---|--|
| 7 | SARP 300 ANIS | Sous-assiette ronde prestige anis | Ø 300 mm | 10 mm |  | 18 × 4 |
| 8 | SARP 300 TURQUOISE | Sous-assiette ronde prestige turquoise | Ø 300 mm | 10 mm |  | 18 × 4 |
| 9 | SARP 300 ORANGE | Sous-assiette ronde prestige orange | Ø 300 mm | 10 mm |  | 18 × 4 |
| 10 | SARP 300 ROSE | Sous-assiette ronde prestige rose | Ø 300 mm | 10 mm |  | 18 × 4 |
| 11 | SARP 300 CIEL | Sous-assiette ronde prestige ciel | Ø 300 mm | 10 mm |  | 18 × 4 |
| 12 | SARP 300 POURPRE | Sous-assiette ronde prestige pourpre | Ø 300 mm | 10 mm |  | 18 × 4 |



Sous-assiette ronde injectée Ø 300



7

SARP 300 ANIS



8

SARP 300 TURQUOISE



9

SARP 300 ORANGE



10

SARP 300 ROSE



11

SARP 300 CIEL



12

SARP 300 POURPRE

Sous-assiette ronde injectée Ø 300



n°



| n° | | | | | | |
|----|-----------------|-------------------------------------|----------|-------|---|--------|
| 13 | SARP 300 ARGENT | Sous-assiette ronde prestige argent | Ø 300 mm | 10 mm | ◆ | 18 × 4 |
| 14 | SARP 300 OR | Sous-assiette ronde prestige or | Ø 300 mm | 10 mm | ◆ | 18 × 4 |



13

SARP 300 ARGENT



14

SARP 300 OR

Coupe dessert (PS, PP)



| n° | | | | | | | | | |
|----|-----------------|---------------------------|---------|-------|--------|-------------|---------|--|--|
| 1 | CP 125 PP | Coupe dessert PP cristal | Ø 95 mm | 57 mm | 155 ml | Translucide | 24 × 25 | | |
| 2 | CP 125 BLACK PP | Coupe dessert PP black | Ø 95 mm | 57 mm | 155 ml | ◆ | 24 × 25 | | |
| 3 | CP 125 PS | Coupe dessert PP cristal | Ø 95 mm | 57 mm | 155 ml | Cristal | 24 × 25 | | |
| 4 | CP 125 NACRE | Coupe dessert PS nacre | Ø 95 mm | 57 mm | 155 ml | ◆ | 12 × 12 | | |
| 5 | CP 125 CARMIN | Coupe dessert PS carmin | Ø 95 mm | 57 mm | 155 ml | ◆ | 12 × 12 | | |
| 6 | CP 125 CHOCOLAT | Coupe dessert PS chocolat | Ø 95 mm | 57 mm | 155 ml | ◆ | 12 × 12 | | |



1

CP 125 PP



2

CP 125 BLACK PP



3

CP 125 PS



4

CP 125 NACRE



5

CP 125 CARMIN



6

CP 125 CHOCOLAT

Coupe dessert (PS, PP)



design & création



| n° | | | | | CP 125 PS | | |
|----|------------------|----------------------------------|---------|-------|-----------|---------|---------|
| 7 | CP 125 MAGENTA | Coupe dessert PS magenta | Ø 95 mm | 57 mm | 155 ml | ◆ | 12 × 12 |
| 8 | CP 125 ANIS | Coupe dessert PS anis | Ø 95 mm | 57 mm | 155 ml | ◆ | 12 × 12 |
| 9 | CP 125 TURQUOISE | Coupe dessert PS turquoise | Ø 95 mm | 57 mm | 155 ml | ◆ | 12 × 12 |
| 10 | CP 125 ORANGE | Coupe dessert PS orange | Ø 95 mm | 57 mm | 155 ml | ◆ | 12 × 12 |
| 11 | CP 125 ROSE | Coupe dessert PS rose | Ø 95 mm | 57 mm | 155 ml | ◆ | 12 × 12 |
| 12 | CP 125 CIEL | Coupe dessert PS ciel | Ø 95 mm | 57 mm | 155 ml | ◆ | 12 × 12 |
| 13 | CP 125 POURPRE | Coupe dessert PS pourpre | Ø 95 mm | 57 mm | 155 ml | ◆ | 12 × 12 |
| 14 | CP 125 ARGENT | Coupe dessert PS argent | Ø 95 mm | 57 mm | 155 ml | ◆ | 12 × 12 |
| 15 | CP 125 OR | Coupe dessert PS or | Ø 95 mm | 57 mm | 155 ml | ◆ | 12 × 12 |
| 16 | COUV PLAT CP | Couvercle plat coupe dessert 125 | Ø 95 mm | 8 mm | - | Cristal | 12 × 50 |
| 17 | DOME CP | Dôme coupe dessert 125 | Ø 95 mm | 25 mm | - | Cristal | 12 × 50 |



7

CP 125 MAGENTA



8

CP 125 ANIS



9

CP 125 TURQUOISE



10

CP 125 ORANGE



11

CP 125 ROSE



12

CP 125 CIEL



13

CP 125 POURPRE



14

CP 125 ARGENT



15

CP 125 OR









16

COUV PLAT CP



17

DOME CP

| n° |  |  |  |  |  |  |  |
|----|--|--|--|---|--|--|--|
| 1 | SD 5 | Coupe dessert 15 PET | Ø 92,6 mm | 32,1 mm | 150 ml | Cristal | 20 × 50 |
| 2 | SD 8 | Coupe dessert 24 PET | Ø 92,6 mm | 65,4 mm | 236 ml | Cristal | 20 × 50 |
| 3 | POS 25 | Pot dessert 25 PET | Ø 92,6 mm | 71 mm | 266 ml | Cristal | 20 × 50 |
| 4 | COUV POS 25 | Couvercle plat pour POS 25, SD 5, SD 8, TS 5 | Ø 92,6 mm | 10 mm | – | Cristal | 10 × 100 |
| 5 | DOME CLIPS POS 30 | Dôme clips pour POS 25, SD 8, SD 5 | Ø 92,6 mm | 26 mm | – | Cristal | 10 × 100 |
| 6 | DOME POS 25 A/T | Dôme avec trou pour POS 25, SD 8, SD 5 | Ø 92,6 mm | 45 mm | – | Cristal | 10 × 100 |
| 7 | DOME POS 25 | Dôme sans trou pour POS 25, SD 8, SD 5 | Ø 92,6 mm | 45 mm | – | Cristal | 10 × 100 |
| 8 | INSERT 4 OZ | Insert pour pot et gobelet Ø 92 | Ø 92,6 mm | – | 120 ml | Cristal | 20 × 50 |



Pot dessert (APET)







Gamme sacherie

p. 174 – p. 177

Sac croissant, sac bretelle, papier cuisson **177**

Sac poulet



n°



| n° | | | | | | |
|----|---------------|------------------------------|-------------|--------|-------|-----|
| 1 | SAC POULET | Sac poulet 180 + 60 × 345 | 180 × 60 mm | 345 mm | Décor | 500 |
| 2 | SAC POULET XL | Sac poulet XL 200 + 80 × 345 | 200 × 80 mm | 345 mm | Décor | 500 |

Nouveaux décors !

1



SAC POULET

2



SAC POULET XL

Sac sandwich



n°



| n° | | | | | | |
|----|---------------|---|-------------|--------|-------|------|
| 1 | SAC SAND 1 BC | Sac sandwich kraft blanc 100 × 60 × 360 | 100 × 60 mm | 360 mm | Blanc | 1000 |
| 2 | SAC SAND 1 CL | Sac sandwich kraft blanc 120 × 30 × 300 | 120 × 30 mm | 300 mm | Blanc | 1000 |
| 3 | SAC SAND 1 KF | Sac sandwich kraft brun à fenêtre 100 × 140 × 360 | 100 × 40 mm | 360 mm | Brun | 1000 |
| 4 | SAC SAND 3 C | Sac sandwich 3 C 100 × 50 × 360 | 100 × 50 mm | 360 mm | Décor | 1000 |

1



SAC SAND 1 BC

2



SAC SAND 1 CL

3



SAC SAND 1 KF

4



SAC SAND 3 C



| | | | | | | |
|-----------------|---|-------------|--------|---------------|------------|------|
| SAC 101 | Sac croissant kraft blanc / brun / vierge | 120 × 50 mm | 150 mm | 2 croissants | Blanc/Brun | 1000 |
| SAC 102 | Sac croissant kraft blanc / brun / vierge | 120 × 50 mm | 210 mm | 4 croissants | Blanc/Brun | 1000 |
| SAC 103 | Sac croissant kraft blanc / brun / vierge | 140 × 60 mm | 210 mm | 6 croissants | Blanc/Brun | 1000 |
| SAC 104 | Sac croissant kraft blanc / brun / vierge | 140 × 60 mm | 280 mm | 8 croissants | Blanc/Brun | 1000 |
| SAC 105 | Sac croissant kraft blanc / brun / vierge | 170 × 70 mm | 310 mm | 12 croissants | Blanc/Brun | 1000 |
| SAC 106 | Sac croissant kraft blanc / brun / vierge | 170 × 70 mm | 360 mm | 16 croissants | Blanc/Brun | 1000 |
| SAC 107 BRIOCHE | Sac croissant kraft blanc / brun / vierge | 250 × 70 mm | 340 mm | – | Blanc/Brun | 500 |



Sac croissant



| | | | | |
|---------------------------------------|--------------------------|------------------|--------|---------|
| SAC BRETELLE 26 × 6 + 6 × 45 BL 50 µm | Sac bretelle blanc 50 µm | 260 × 60 + 60 mm | 450 mm | 5 × 100 |
| SAC BRETELLE 30 × 7 + 7 × 54 BL 50 µm | Sac bretelle blanc 50 µm | 300 × 70 + 70 mm | 540 mm | 8 × 50 |



SAC BRETELLE 50 µm

Sac bretelle

n°



| | | | | |
|---|------------------|------------------------|--------------|-----|
| 1 | PAP CUIS 53 × 32 | Papier cuisson 53 × 32 | 530 × 320 mm | 500 |
| 2 | PAP CUIS 40 × 60 | Papier cuisson 40 × 60 | 400 × 600 mm | 500 |

1



PAP CUIS 53 × 32

2



PAP CUIS 40 × 60

Papier cuisson

BOÎTE DISTRIBUTRICE | MULTI-PASSAGE 41 G



Gamme nappage

| | |
|---|-----|
| Serviette ouate couleur | 181 |
| Serviette micro gaufrée, serviette non-tissée | 182 |
| Personnalisation serviette | 183 |
| Nappe damassée | 184 |
| Nappe non-tissée | 185 |

Serviette ouate



n°



| n° | Code | Description | Couleur | Dimensions |
|----|--------------------|--------------------------|---------|------------|
| 1 | SERV 20 × 20 BL 2F | Serviette 20 × 20 2 plis | Blanc | 60 × 100 |
| 2 | SERV 30 × 30 BL 1F | Serviette 30 × 30 1 pli | Blanc | 10 × 500 |
| 3 | SERV 30 × 30 BL 2F | Serviette 30 × 30 2 plis | Blanc | 32 × 100 |
| 4 | SERV 30 × 40 BL 2F | Serviette 30 × 40 2 plis | Blanc | 36 × 100 |
| 5 | SERV 40 × 40 BL 2F | Serviette 40 × 40 2 plis | Blanc | 24 × 100 |



1

SERV 20 X 20 BL 2F



2

SERV 30 X 30 BL 1F



3

SERV 30 X 30 BL 2F



4

SERV 30 X 40 BL 2F



5

SERV 40 X 40 BL 2F

n°



Serviette ouate couleur

| | | | | |
|---|-----------------------|--------------------------|--|----------|
| 1 | SERV 40 × 40 (PASTEL) | Serviette 40 x 40 2 plis | Ivoire, saumon | 24 × 100 |
| 2 | SERV 40 × 40 (VIVE) | Serviette 40 x 40 2 plis | Bordeaux, bleu, turquoise, fuchsia, gris, mandarine, noir, rouge, vert sapin, chocolat, jaune, terra cotta | 24 × 100 |

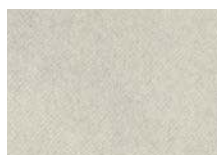

IVOIRE

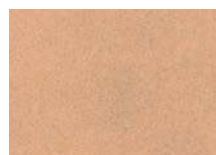

SAUMON

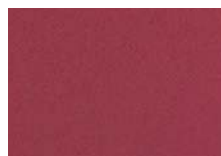

BORDEAUX

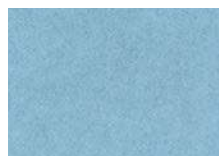

BLEU



TURQUOISE

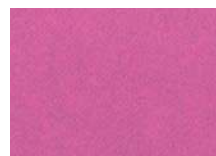

FUCHSIA



GRIS



MANDARINE



NOIR



ROUGE



VERT SAPIN



CHOCOLAT



JAUNE

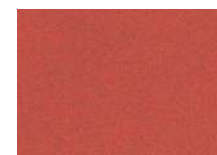

TERRA COTTA

Serviette micro gaufrée



| | | | |
|-----------------------------|---------------------------------------|--|---------|
| SERV MICRO 40 X 40 (BLANC) | Serviette micro gaufrée 2 plis | Blanc | 36 × 50 |
| SERV MICRO 40 X 40 (PASTEL) | Serviette micro gaufrée 2 plis pastel | Crème, saumon | 36 × 50 |
| SERV MICRO 40 X 40 (VIVE) | Serviette micro gaufrée 2 plis vive | Jaune, rouge, bordeaux, vert, bleu, noir, prune, gris, anis, fuchsia, chocolat, mandarine, terra cotta, turquoise, bleu ciel | 36 × 50 |

Serviette non-tissée



| | | | |
|--------------------------|-------------------------------------|--|---------|
| SERV 40 × 40 NT (BLANC) | Serviette 40 × 40 non-tissée | Blanc | 24 × 50 |
| SERV 40 × 40 NT (PASTEL) | Serviette 40 × 40 non-tissée pastel | Ivoire | 24 × 50 |
| SERV 40 × 40 NT (VIVE) | Serviette 40 × 40 non-tissée vive | Bleu, noir, rouge, cacao, gris souris, jaune | 24 × 50 |

Personnalisable !



Que ce soit pour le buffet ou encore le repas, nous vous proposons une gamme de serviettes papier personnalisées.

Les serviettes de table personnalisées sont une façon originale de marquer l'événement. Elles sont disponibles dans un large choix de coloris.

Vous pourrez également choisir la couleur d'impression, insérer votre logo pour correspondre à votre fête mais aussi à votre thème.

Nappe damassée



6 m 10 m 25 m 50 m 100 m

| NAPPE DAMASSE 1,20 | Couleur | Blanc | • | • | • | • |
|--------------------|----------------|---|---|---|---|---|
| NAPPE DAMASSE 1,20 | Couleur pastel | Turquoise, bleu ciel, parme, cyclamen, pêche, paille | • | • | • | |
| NAPPE DAMASSE 1,20 | Couleur pastel | Ivoire, gris | • | • | • | |
| NAPPE DAMASSE 1,20 | Couleur vive | Vert kiwi, vert pomme, vert sapin, bleu marine, rose | • | • | • | |
| NAPPE DAMASSE 1,20 | Couleur vive | Bordeaux, rouge, orange, jaune d'or, jaune, chocolat, taupe | • | • | • | |
| NAPPE DAMASSE 1,20 | Couleur vive | Noir, argent | • | • | • | |



VERT KIWI



VERT POMME



VERT SAPIN



BLEU MARINE



TURQUOISE



BLEU CIEL



ORANGE



ROSE



BORDEAUX



ROUGE



JAUNE D'OR



JAUNE

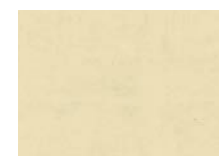

IVOIRE



CHOCOLAT



TAUPE



GRIS



NOIR



BLANC



ARGENT



6 m 15 m 50 m

| | | | | | |
|-----------------------|----------------|---|---|---|---|
| NAPPE NON TISSEE 1,20 | Couleur | Blanc | • | • | • |
| NAPPE NON TISSEE 1,20 | Couleur pastel | Kiwi, anis, lilas, pivoine, ivoire | • | • | • |
| NAPPE NON TISSEE 1,20 | Couleur pastel | Bleu azur, gris | • | • | • |
| NAPPE NON TISSEE 1,20 | Couleur vive | Vert sapin, bleu marine, bordeaux, aubergine, rouge | • | • | • |
| NAPPE NON TISSEE 1,20 | Couleur vive | Orange, jaune, turquoise, chocolat, noir | • | • | • |

Nappe non-tissée

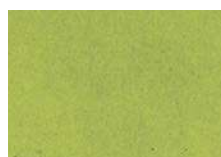

KIWI



ANIS



VERT SAPIN



BLEU MARINE



LILAS



BORDEAUX



AUBERGINE



ROUGE

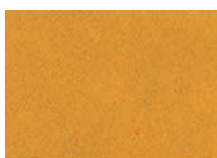

ORANGE



JAUNE



PIVOINE

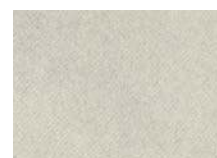

IVOIRE



TURQUOISE

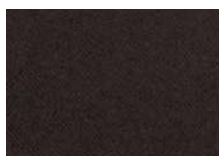

CHOCOLAT



BLEU AZUR



BLANC



GRIS

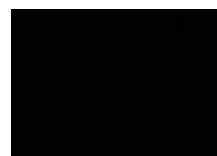

NOIR



Ingenico

Desk/5000

DEBIT COMMERCE
MONTANT : 701 000079
FTH 31/01/23
A88DCBF
497783
2010
7470110
28100
DREUX
BOULANG
LE 23/01/22 A 13:42:49
CB



CARTE BANCAIRE

Gamme accessoire

p. 186 – p. 189

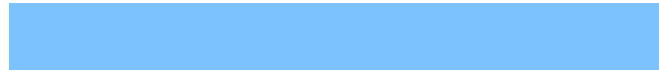

Essuie-mains



1

ESSUIE-MAINS

| n° | | | | | |
|----|----------------------|---|--------------|-------|-------|
| 1 | ESSUIE-MAINS 200 | Essuie-tout 2 plis blanc 200 formats | 200 × 230 mm | Blanc | 4 × 3 |
| 1 | ESSUIE-MAINS 450 | Essuie-tout 2 plis blanc 450 formats lisse | 199 × 280 mm | Blanc | 6 |
| 2 | ESSUIE-MAINS 450 ECO | Essuie-tout 2 plis blanc 450 formats gaufré | 200 × 240 mm | Blanc | 6 |
| 3 | ESSUIE-MAINS 1000 | Essuie-tout 2 plis blanc 1000 formats | 230 × 300 mm | Blanc | 2 |



2

ESSUIE-MAINS 450 ECO



3

ESSUIE-MAINS 1000

Bloc maître d'hôtel, bobine thermique et rince-doigts



BOB 57 X 40

BOB 80 X 80

1

BLOC DUPLI ET BOB

| n° | | | | | |
|----|-------------------|-------------------------------|-------------|-------|--------|
| 1 | BLOC DUPLI 8 × 15 | Bloc maître hôtel 8 × 15 cm | 80 × 150 mm | Blanc | 5 × 10 |
| 1 | BLOC DUPLI 9 × 17 | Bloc maître hôtel 9,5 × 17 cm | 95 × 170 mm | Blanc | 5 × 10 |
| 1 | BOB 57 × 40 | Bobine thermique 57 × 40 cm | 57 × 40 mm | Blanc | 5 × 10 |
| 1 | BOB 80 × 80 | Bobine thermique 80 × 80 cm | 80 × 80 mm | Blanc | 10 × 3 |
| 2 | RINCE-DOIGTS | Rince-doigts | 59 × 80 mm | Blanc | 1000 |



2

RINCE-DOIGTS



A

| | |
|-------------------------------|----------------------------------|
| Assiette..... | 40-41, 64, 126, 150-156, 160-166 |
| Assiette carrée..... | 41, 150-156 |
| Assiette carrée injectée..... | 150-156 |
| Assiette carton..... | 08 |
| Assiette ronde..... | 40, 160-166 |
| Assiette ronde injectée..... | 160-166 |

B

| | |
|---|--|
| Barquette..... | 20-21, 46, 65, 78-85, 92-93, 98-101, 115 |
| Barquette charcutière translucide..... | 92-93 |
| Barquette gastronomique thermoscellable pour préparation froide..... | 100 |
| Barquette gastronomique injectée pour préparation chaude..... | 101 |
| Barquette four..... | 21 |
| Barquette injectée..... | 115 |
| Barquette menu fibre naturelle..... | 46 |
| Barquette noire thermoscellable pour préparation chaude..... | 99 |
| Barquette operculable..... | 78-80 |
| Barquette plage lisse..... | 82-85 |
| Barquette plage lisse, cuivrée..... | 82 |
| Barquette rectangulaire..... | 20 |
| Barquette translucide thermoscellable pour préparation chaude..... | 98 |
| Bloc maître d'hôtel..... | 188 |
| Bobine thermique..... | 188 |
| Boîte à couvercle séparé..... | 106-107, 109 |
| Boîte à pizza..... | 28 |
| Boîte charnière micro-ondable..... | 102 |
| Boîte lunch..... | 33 |
| Boîte pâtissière..... | 34-35 |
| Boîte pour coquille..... | 125 |
| Boîte salade..... | 19, 88, 90-91, 94 |

| | |
|---|----------------|
| Boîte salade charnière..... | 88, 90 |
| Boîte salade charnière déchirable..... | 90 |
| Boîte salade design à couvercle séparé..... | 94 |
| Boîte take away..... | 19 |
| Bol..... | 41, 44-45, 127 |
| Bol carré fibre naturelle..... | 45 |
| Bol fibre naturelle..... | 44 |

C

| | |
|--------------------------------|-------------|
| Carty box..... | 115 |
| Carré rainé..... | 33 |
| Combo..... | 81 |
| Coque hamburger..... | 18, 43 |
| Coque poulet..... | 109 |
| Coquille..... | 66, 125 |
| Coquille plastique..... | 125 |
| Cornet à frites..... | 20 |
| Coupe à glace..... | 27 |
| Coupe dessert..... | 171-172 |
| Coupelle..... | 73 |
| Couvercle cristal..... | 96-97 |
| Couvercle en carton..... | 12 |
| Couvert..... | 50, 52, 129 |
| Couvert bambou..... | 52 |
| Couvert en bois..... | 50 |
| Couvercle plat menu..... | 111 |
| Couvert Rlux réutilisable..... | 129 |
| Cristal box..... | 114 |

D

| | |
|-------------------------------|---------|
| Dérouleur..... | 58-61 |
| Dérouleur Filmacut..... | 58 |
| Design & création..... | 138-172 |
| Distributeur de gobelets..... | 14 |
| Dôme pour coupe à glace..... | 27 |

E

| | |
|-------------------|---------|
| Éco box..... | 106-109 |
| Ergo box..... | 88 |
| Essuie-mains..... | 188 |

F

| | |
|-------------------------|---------|
| Film alimentaire..... | 57-60 |
| Film cuisson..... | 60 |
| Filmacut..... | 58 |
| Flûte réutilisable..... | 136-148 |
| Food box..... | 21 |
| Fresh box..... | 90 |

G

| | |
|----------------------------|---------------|
| Gastro box..... | 100-101 |
| Gobelet..... | 10-12, 14, 46 |
| Gobelet blanc..... | 11 |
| Gobelet brun..... | 11 |
| Gobelet compostable..... | 46 |
| Gobelet conique..... | 14 |
| Gobelet froid Emocath..... | 12 |
| Gobelet hôtel..... | 11 |
| Godet..... | 66 |

I

| | |
|--------------|-----|
| INJ box..... | 113 |
|--------------|-----|

K

| | |
|---------------------------|----|
| Kit couverts bambou..... | 52 |
| Kit couverts en bois..... | 50 |

M

| | |
|---------------------|---------|
| Menu box..... | 110 |
| Micro box..... | 102 |
| Moule..... | 67, 119 |
| Moule traiteur..... | 119 |

N

| | |
|------------------------|-------------------|
| Nappe..... | 184-185 |
| Nature & création..... | 08, 27, 40-47, 53 |

O

| | |
|---------------|----|
| Ombrelle..... | 53 |
|---------------|----|

P

| | |
|---------------------------|--|
| Paille papier..... | 47 |
| Palmier..... | 53 |
| Papier cuisson..... | 177 |
| Part de tarte..... | 125 |
| Part pizza..... | 33 |
| Part quiche..... | 33 |
| Personnalisation..... | 10-13, 16-28, 34, 36-37, 117, 128, 173, 176, 180-183 |
| Piques..... | 51, 53 |
| Pique en bois..... | 51 |
| Pique bambou..... | 53 |
| Plat..... | 68-71, 74, 104-105, 110 |
| Plat à compartiments..... | 69, 104-105 |
| Plat gastronomique..... | 70-71 |
| Plat menu..... | 110 |
| Plat ovale..... | 74 |
| Plateau..... | 30-32, 42, 72, 122, 130 |
| Plateau présentation..... | 72 |
| Plateau repas..... | 42, 122 |

| | |
|-----------------------|---|
| Plateau traiteur..... | 30-31 |
| Porte-gobelets..... | 14 |
| Pots..... | 16-17, 22-27, 42, 113, 116, 118, 119, 120, 128, 173 |
| Pot à coulis..... | 117-118 |
| Pot à pâtes..... | 24-25 |
| Pot à sauce..... | 42, 116 |
| Pot à soupe..... | 16-17 |
| Pot à vis..... | 120 |
| Pot bucket..... | 26 |
| Pot crème..... | 119 |
| Pot dessert..... | 173 |
| Pot fast..... | 128 |
| Pot salade..... | 22-23 |
| Pot plissé..... | 27 |
| Pot rond..... | 113 |
| Pot whizz..... | 26 |
| Pot wrap..... | 24-25 |
| Presti box..... | 94 |

R

| | |
|------------------------|-----|
| Ramequin..... | 74 |
| Rince-doigts..... | 188 |
| Rouleau aluminium..... | 56 |

S

| | |
|------------------------------|-------------|
| Sacs..... | 36, 176-177 |
| Sac bretelle..... | 177 |
| Sac croissant..... | 177 |
| Sac kraft..... | 36-37 |
| Sac poulet..... | 176 |
| Sac sandwich..... | 176 |
| Salade box..... | 91 |
| Saladier..... | 96-97 |
| Serviette..... | 180-183 |
| Serviette micro gaufrée..... | 182 |
| Serviette non-tissée..... | 182 |
| Serviette ouate..... | 180 |

| | |
|-----------------------------------|---------|
| Serviette ouate couleur..... | 181 |
| Sous-assiette carrée..... | 157-158 |
| Sous-assiette ronde injectée..... | 168-170 |
| Spatule en bois..... | 51 |

T

| | |
|------------------------|-------|
| Tartelette..... | 74 |
| Thermo box..... | 98-99 |
| Tourtière..... | 76-77 |
| Trépied pizza..... | 29 |
| Triangle sandwich..... | 125 |

V

| | |
|-------------------------------|---------|
| Verres..... | 135-148 |
| Verre à eau réutilisable..... | 138-148 |
| Verre à vin réutilisable..... | 138-148 |
| Verre injecté cristal..... | 135 |
| Verre réutilisable..... | 136-148 |
| Verrines..... | 131-135 |



